

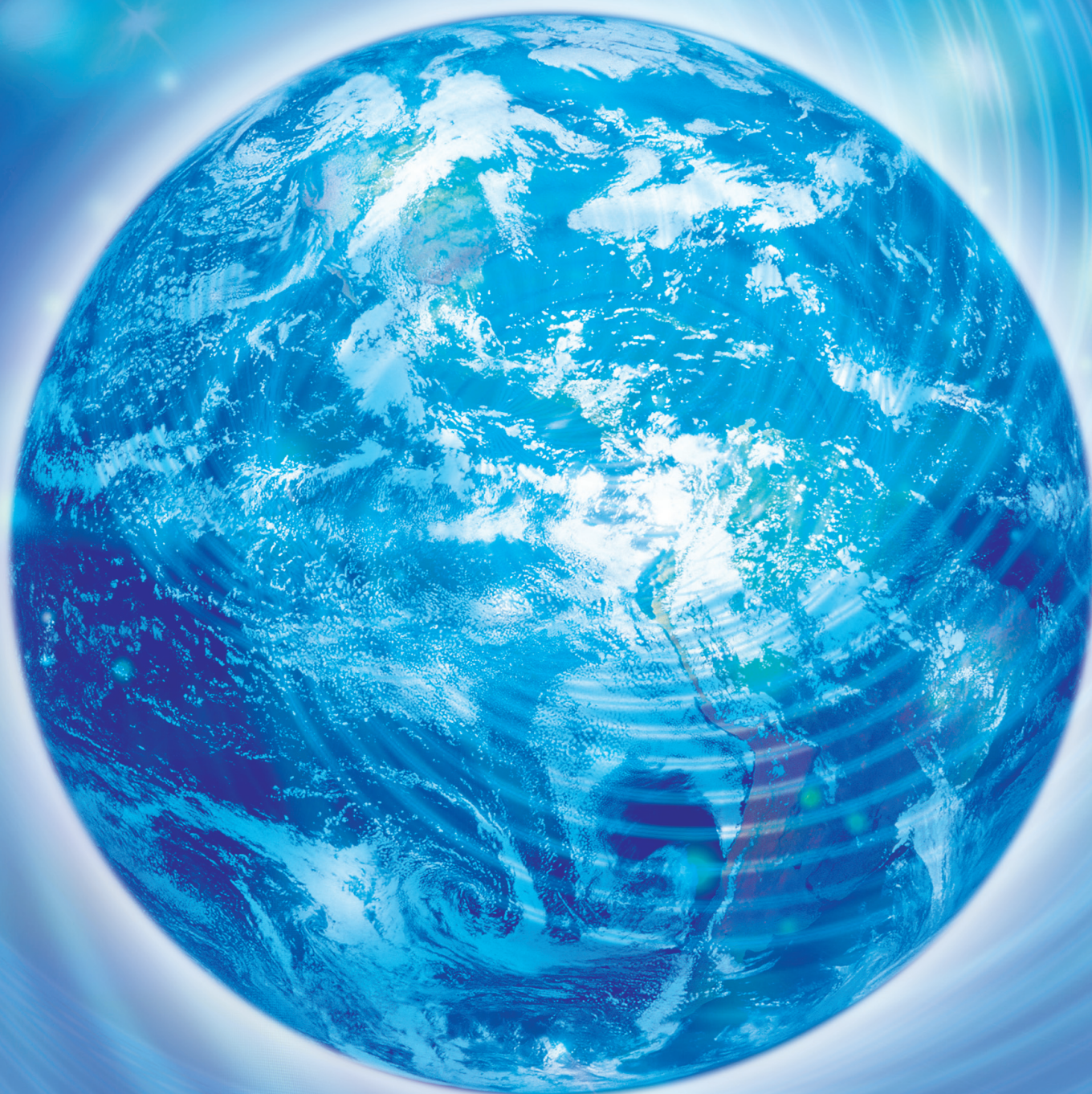

**Research Institute of
Electrical Communication
Tohoku University**

2011/2012





CONTENTS

- Chronology 1
- Organization 5
- Nation-wide Cooperative Research Projects ... 8
- Research Fields 9
- Research Division
 - Information Devices Division 11
 - Broadband Engineering Division 17
 - Human Information Systems Division 25
 - Systems & Software Division 31
 - Sponsored Division 38
- Laboratory for Nanoelectronics
and Spintronics 40
- Laboratory for Brainware Systems 47
- Research Center for 21st Century
 - Information Technology 53
- Flexible Information System Research Center ... 57
- Fundamental Technology Center 59
- Management Office for Safety and Health ... 60
- Research Activities
 - Study Groups on Electrical Communication ... 61
 - Symposiums Organized by the Institute ... 62
 - Periodicals Published by the Institute 64
- Educational Activities 65
- International Activities 66
- RIEC Open Day 68
- Staff 69

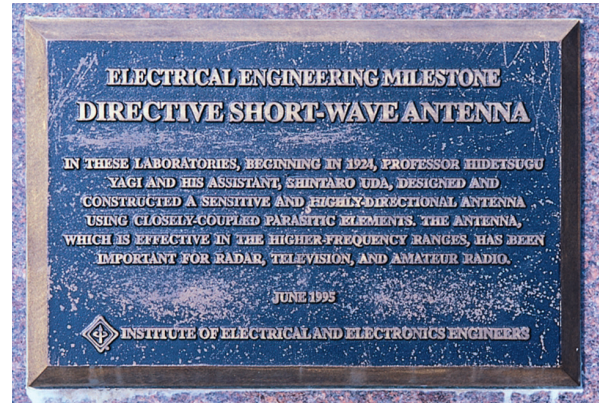

IEEE Electrical Engineering Milestone
for Yagi-Uda Antenna



IEEE Electrical Engineering Milestone
for Yagi-Uda Antenna (in Katahira Campus)



Greeting from the Director



**Director Prof.
Masataka NAKAZAWA**

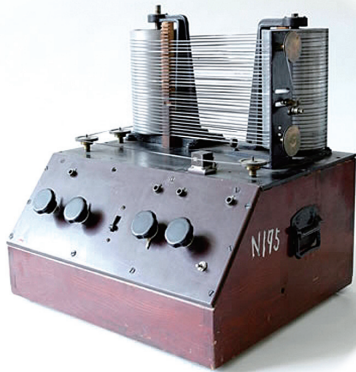

- ① Experimental equipment for Yagi-Uda Antenna (1929)
- ② Experimental equipment for Split Anode Magnetron (1927)
- ③ Experimental equipment for AC-bias magnetic recording (1937)

It would be no exaggeration to say that we owe the civilization created between the nineteenth and the twenty-first centuries to the information and communications industry and the electronics industry. This is represented by such technologies as the telephone, television, personal computer, mobile phone, and the Internet. Moreover, in terms of GDP, while most of Japan's industries have been showing little growth, the information and communications technology (ICT) sector has continued to expand at an annual rate of about 7 percent.

Tohoku University's Research Institute of Electrical Communication was established in 1935 in affiliation with the School of Engineering, where pioneering work on information and communications had already resulted in breakthroughs such as the Yagi-Uda antenna and the split-anode magnetron. Well known both by its Japanese abbreviation "Tsuken" and by the acronym RIEC, the Institute has contributed in no small measure to the progress that has been made on telecommunications technology over the past 75 years. From its early work with weak-current electricity, RIEC first became a leader in the field of electromagnetic and electronic devices. We have since added transmission, human interface, and software technologies, and today our integrated research covers everything from devices to software. Our organization consists of four major research divisions (Information Devices, Broadband Engineering, Human Information Systems, and Systems and Software), two experimental facilities (the Laboratory for Nanoelectronics and Spintronics, and the Laboratory for Brainware Systems), and the Research Center for 21st Century Information Technology, or IT21 Center.

The massive disaster that struck the Tohoku region on March 11 taught those of us concerned with the information and communications infrastructure some severe lessons. The fact that the mobile phone service was all but lost and optical fiber networks were disrupted revealed that an information and communications network on the cutting edge of global technology is vulnerable to a disaster of this magnitude. The task of building a disaster-resistant network falls naturally to our Tohoku University Group of Electrical Engineering, Communication Engineering, Electronic Engineering, and Information Engineering, whose nearly 80 laboratories make it Japan's largest electronic and computer engineering community, and our future depends on rising to this challenge. It is important that we identify real needs by asking people living in the disaster stricken areas what problems they faced, and then bring our proposed solutions to the practical stage as quickly as possible and introduce them in cooperation with local authorities in the affected areas, through a partnership among academia, industry, and government. I feel sure that many innovative technologies will see the light of day as a result of this work. The challenge that lies ahead will require a nationwide response, and we are committed to serve as its nucleus.

I look forward to your continuing support and encouragement as we at RIEC forge ahead toward achieving our goals, united in our renewed commitment and enthusiasm.

Chronology

1. Birth

Telecommunications research at Tohoku University began in 1919 with the establishment of the Department of Electrical Engineering in the university's School of Engineering. In that era, work was centered on strong-current electrical engineering, but upon the establishment of this department attention turned to weak-current electrical engineering.

In 1924, the Saito Foundation granted what in those days was a huge sum to fund research by three professors, Hidetsugu Yagi, Heiichi Nukiyama, and Shigetaro Chiba, into communication methods using electricity. As a result, telecommunications related research was conducted systematically for the first time in Japan. The department was subsequently strengthened by the addition of a succession of gifted young researchers such as Yasushi Watanabe, Masatoshi Matsudaira, Kinjiro Okabe, Shintaro Uda, Kenzo Nagai, and Katsuichiro Kobayashi. The fruits of their research were considerable, as reflected by the publication of numerous papers in journals both in Japan and overseas that attracted widespread attention.

Along with subsequent advances in telecommunications technologies and the spread of communications equipment, the importance of telecommunications related research became increasingly recognized, fueling a groundswell of opinion in favor of setting up a research establishment to undertake telecommunications research at the Tohoku Imperial University. The university's statutes were revised and an affiliated telecommunications research institute was established. Professor Heiichi Nukiyama was appointed as the first head of the new institute, and he had a full-time staff comprising three assistant professors, six assistants, and one secretary.

Given its intended evolution into an entity independent of the Department of Electrical Engineering, this research institute was designed to function in parallel with the School of Engineering, but shared premises with the Department of Electrical Engineering, and its research facilities were conventional. It maintained an arm's length relationship with the Department of Electrical Engineering and the number of people who functioned effectively as regular staff was far larger than the number of regular staff prescribed by its statutes. This strengthened both the organization and the content of its research, enabling it to produce noteworthy results.

2. Cradle and growth

In response to society's need for telecommunications engineers, the Department of Electrical Communication was established within the School of Engineering in 1941. As part of a three-entity cooperative structure that included the Department of Electrical Engineering and the Department of Electrical Communication, the Research Institute of Electrical Communication (RIEC) achieved considerable success in a diverse range of research projects and produced a large number of skilled personnel through its research and education activities. In this way, it steadily built up a tradition of combined operations.

As a result of a statutory change, in 1944, RIEC, hitherto a telecommunications research institute affiliated with Tohoku University, was given the status of an integral research institute. It had an independent research institute structure comprising five divisions staffed by full-time professors, but firmly retained a system of close links with the Department of Electrical Engineering and with communications engineering.

During the difficult circumstances of the postwar period, work continued in the research facilities, which had narrowly escaped wartime destruction. As a result of the promulgation of the National School Establishment Act in 1949, Tohoku University was re-established with the status of a national university, and RIEC became one of its integral research institutes.

Owing to the subsequent rapid progress made in the field of electronics, there were successive increases in the number of research divisions with the addition of one in 1954 and 1957, four in 1961, three in 1962 and 1963, and one in each of 1965, 1969, and 1976. This saw RIEC develop into a major research institute with 20 research divisions and some 100 teaching staff.

The year 1956 saw the completion of the institute's first independent building (currently part of the Institute of Multidisciplinary Research for Advanced Materials) on the Katahira Campus, formerly in the Sakurakoji district of Sendai. The end of March 1963 saw the completion of a new building (currently S Block No. 1 Building) that was double the size of its predecessor on the Katahira Campus formerly in the Minami Rokken-cho district, marking the beginning of a move from the Sakurakoji district to the Minami Rokken-cho district. When the School of Engineering transferred to Aobayama in 1966, the former Department of Electronic Engineering building (currently N Block, No. 1 Building) became an RIEC building, as did the building (currently No. 2 Building) of the Training School of Engineering Teachers upon its closure in 1969. This completed the transfer of all the divisions.

The Laboratory for Microelectronics (operating for a limited period until March 1994) was established in 1984, and the Super Clean Room block was completed in 1986. The Laboratory for Electronic Intelligent Systems was established in April 1994 as an advanced version of the Laboratory for Microelectronics.

In 1958 the electricity related departments of the School of Engineering, with which RIEC was closely associated, were supplemented by the addition of the Department of Electronic Engineering. Subsequent milestones included the establishment of the Research Center for Applied Information Science in 1972 and increases in the number of information engineering majors in the Graduate School of Engineering in 1973 and in the information engineering departments in the School of Engineering in 1984. With this as a basis, the Graduate School of Information Sciences was newly established in 1993.

With greater emphasis being placed on graduate schools, in 1994 the electrical, communication science, and electronic engineering majors in the Graduate School of Engineering became electrical and communication engineering and electronic engineering majors. With greater emphasis being placed on graduate schools, in 1994 the courses in electrical, communication science, and electronic engineering in the Graduate School of Engineering were replaced with courses in electrical and communication engineering and electronic engineering. A total of nine courses were instituted, including full-time courses. In addition, four electricity related departments and the Department of Applied Physics were amalgamated in 2007 to form the Department of Information and Intelligent Systems. In addition, 2008 saw the establishment of Japan's first Department of Biomedical Engineering, with the aim of fusing medicine and engineering with active input from the electrical field.

3. Development: From national collaborative research institute to joint usage/research center

In 1995 RIEC celebrated the 60th anniversary of its establishment. To mark the occasion it sought to meet the needs of the impending advanced information society by reorganizing itself as a national collaborative research institute. In June 1994, approval was given for RIEC to become a national collaborative research institute engaging in both theoretical and applied research relating to high-density and advanced information communications, whereupon it reorganized into three broad research divisions: Brain Computing, Materials Science and Devices, and Coherent Wave Engineering. In addition, to replace the Laboratory for

Microelectronics, which had reached its specified duration, the Laboratory for Electronic Intelligent Systems was established across the three divisions.

The backdrop to this was the IT revolution, characterized by rapid progress in information and communication technologies, which made the information society a reality. To ensure that RIEC played a leading role in the information society, in 2001 its philosophy, objectives, and goals were reformulated.

RIEC has defined its philosophy as follows: "Close and smooth communication between people is fundamental to maintaining and developing a flourishing and humane society. We will contribute to the well-being not only of Japan but also of human society as a whole through the rapid development of science and technology related to communication." In addition, RIEC pledged that, based on the results of research conducted hitherto in relation to high-density and advanced information communications, it would play a pivotal role in undertaking comprehensive research into the theory and application of science and technology that will provide communication approaches that benefit humankind.

Also, in April 2002, RIEC established the Research Center for 21st Century Information Technology in compliance with a ministerial ordinance. Straddling the three research divisions, the center's aim is to address, through collaborations between industry and academia, the changes that occur in the fabric of society, leading to the creation of new information and communication industries.

In 2009, major changes were made to the organization of university research institutes and centers; the national collaborative research institutes were abolished, and joint usage/research centers were established. A council for joint usage/research centers was set up in April 2010. These centers involve not only the joint use of facilities but also the conduct of joint research; something that is strongly desired by the research community.

At the time of the change to a collaborative research institute in 1994, RIEC's intention was to operate with its orientation towards joint research, gathering research scientists together from a broad range of backgrounds both within Japan and overseas, and pursuing joint research projects. In this regard, RIEC anticipated the main goal of these new centers. In recognition of its achievements, RIEC has been accredited as a joint usage/research center.

4. Leap forward: As a world center of excellence

To realize RIEC's philosophy and goals in the coming era of next-generation global, ubiquitous information communication, an appropriate research system has been put in place. In fiscal 2004 a reorganization was undertaken that considered the research time scale, in addition to the research fields themselves. Research was divided broadly into short-, medium-, and long-term research, and we introduced flexibility to enable the organization to be changed fluidly according to the progress of the research. A major role in short-term research is played by the Research Center for 21st Century Information Technology, which facilitates the practical application of the excellent research results achieved by RIEC within approximately five years through collaboration between industry and academia. We have also set up a Laboratory for Nanoelectronics and Spintronics to engage in research over medium-term spans of approximately 10 years. It undertakes comprehensive and intensive research into material and device technologies based on nanotechnology. We have also established the Laboratory for Brainware Systems, whose aim is to build intelligent integrated systems that break down the barriers of present-day information technologies, conducting fundamental research with a

view to practical applications. To promote research at the Laboratory for Nanoelectronics and Spintronics, in March 2004 we completed the Nanoelectronics and Spintronics integrated research block, which is equipped with the latest technology.

Long-term research has been reorganized into four major research divisions. The Materials Science and Devices Division and the Coherent Wave Engineering Division, which developed scientific techniques for transmitting large volumes of information accurately at high speed, are both in fields in which RIEC has traditionally been strong. These units have been reorganized into the Information Devices Division and the Broadband Engineering Division, respectively. Moreover, to build an advanced information society in which humankind and the environment are in harmony, we have established the Human Information Systems Division, which aims to elucidate the ways in which human beings process information, and the Systems and Software Division, whose goal is to develop software and systems to advance and enhance the information and communication systems that underpin the information society.

RIEC has structures for close cooperation in the spheres of research and education with the School of Engineering (Electrical and Communication Engineering, Electronic Engineering), the Graduate School of Information Sciences, and the Graduate School of Biomedical Engineering. At the same time it welcomes researchers from within Japan and from all over the world, and as a world center of excellence its duty is to engage vigorously in research activities in a wide range of fields related to telecommunications. Building on the proud record of achievement of our distinguished predecessors and colleagues, we are entering a new era in which we hope to make further leaps forward amid the rapid development of information and communication technologies and the rising tide of globalization.

Organization

1. Organization Chart

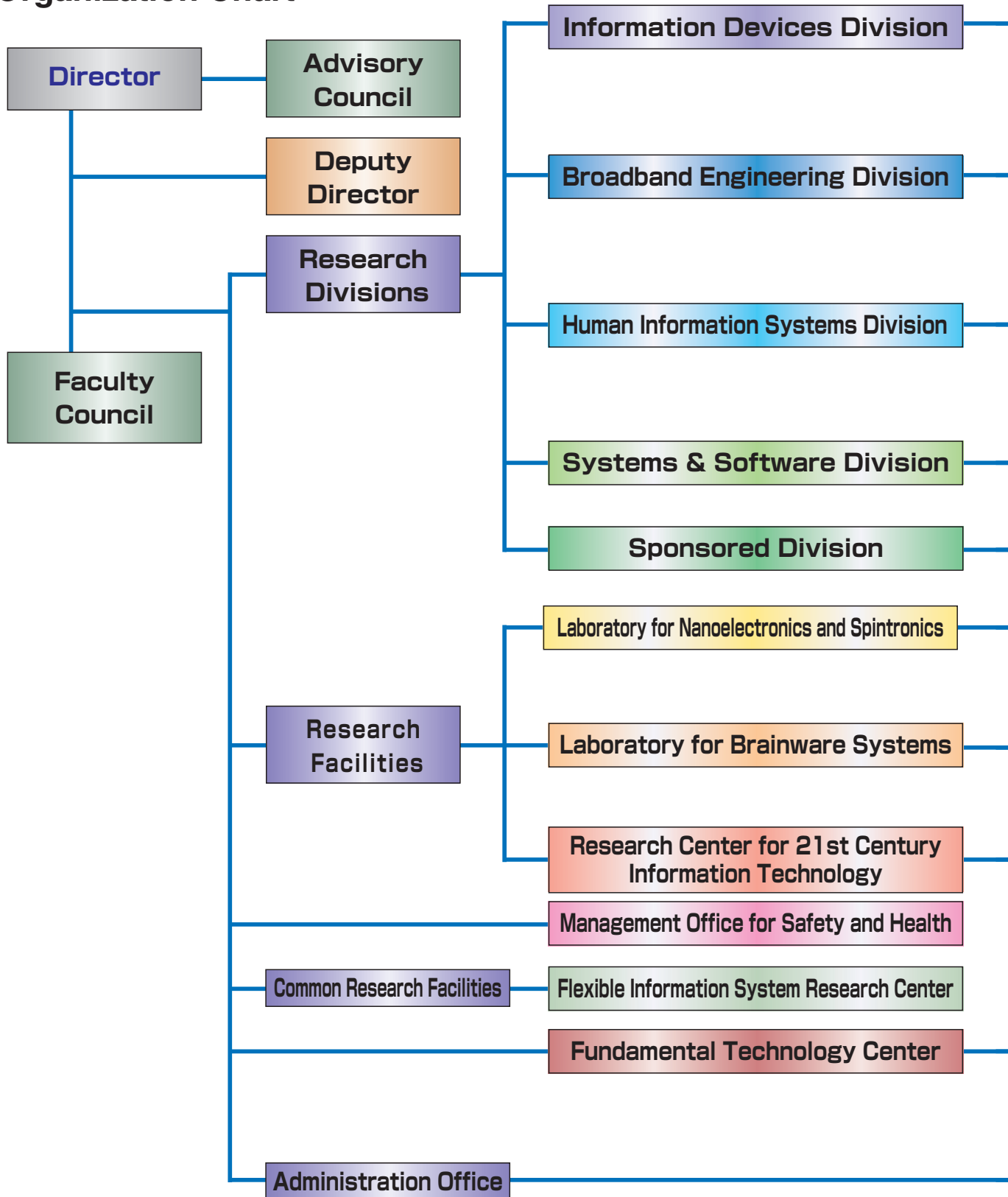

	Nano-Photoelectronics
	Quantum-Optical Information Technology
	Solid State Electronics
	Dielectric Nano-Devices
	Materials Functionality Design
	Magnetic Devices(Visitor Section)

	Ultrahigh-Speed Optical Communication
	Applied Quantum Optics
	Advanced Wireless Information Technology
	Information Storage Systems
	Ultra-Broadband Signal Processing
	Basic Technology for Broadband Communication(Visitor Section)

	Electromagnetic Bioinformation Engineering
	Advanced Acoustic Information Systems
	Visual Cognition and Systems
	Ubiquitous Communications System
	Multimodal Computing (Visitor Section)

	Software Construction
	Computing Information Theory
	Communication Network
	Information Contents
	Information Social Structure(Visitor Section)

Environmental-Adaptive Information and Communication Engineering

	Atomically Controlled Processing
	Semiconductor Spintronics
	Nano-Molecular Devices
	Nano-Spin Memory

	Real-World Computing
	Intelligent Nano-Integration System
	Microarchitecture
	New Paradigm VLSI System

	Project Planning Division
	Technology Development Division: Mobile Wireless Technology Group Storage Technology Group Intelligence Archive Group(Visitor Section)

	Machine Shop Division
	Evaluation Division
	Process Division
	Software Technology Division

	General Affairs Section
	Cooperative Research Section
	Library Section
	Accounting Section
	Purchasing Section

2. Staff

(2011.7.1)

Classification	Division	Laboratory for Nanoelectronics and Spintronics	Laboratory for Brainware Systems	Research Center for 21st Century Information Technology	Fundamental Technology Center	Administration Office	Total
Professors	19	3	4	1			27
Associate Professors	13	5	1	1			20
Assistant Professors	18	3	6				27
Research Fellows	13	4	2				19
Technical Officials					15	2	17
Administrative Officials						13	13
Total	63	15	13	2	15	15	123

3. Land and Buildings

Site: Katahira 2-1-1, Aoba-ku, Sendai 980-8577, Japan

Total building area: 12,913m²

Total floor area: 28,776m²

(2011.7.1)

Name of Buildings	Structure	Year of Completion	Floor Area
Building No.1	Reinforced Concrete, 4 floors	Building-S:1962,1963 Building-N:1959,1960	7,772m ²
Building No.2	Reinforced Concrete, 4 floors	1962,1963	7,085m ²
Laboratory for Nanoelectronics and Spintronics	Steel-frame, 5 floors	2004	7,375m ²
Laboratory for Brainware Systems	Reinforced Concrete, 1 floor	1967,1968,1972	525m ²
	Reinforced Concrete(partly steel-frame), 2 floors	1986	1,553m ²
	Steel-frame 1 floor	1996	598m ²
	Light-weight steel-frame, 2 floors	1999	147m ²
Research Center for 21st Century Information Technology	Reinforced Concrete, 3 floors	1930	1,343m ²
	Steel-frame 1 floor	2002	435m ²
Evaluation and Analysis Center	Reinforced Concrete, 2 floors	1981	790m ²
Helium Sub-Center	Reinforced Concrete(partly light-weight steel-frame),1 floor	1972	166m ²
Machine Shop	Reinforced Concrete(partly light-weight steel-frame),1 floor	1965,1966,1978	479m ²
Others			508m ²
Total			28,776m ²

4. Budget

(Unit:1,000Yen)

Financial Year	Personnel Expenditure	Supplies Expenditure	Research Grant		Total
			Ministry of Education, Science and Culture	Partnership Between Universities and Industry	
2006	971,482	927,090	599,040	937,441	3,435,053
2007	970,961	813,724	700,615	888,833	3,374,133
2008	879,481	953,000	694,883	1,069,832	3,597,196
2009	1,026,511	1,562,318	605,100	798,053	3,991,982
2010	777,776	735,496	418,680	962,712	2,894,664

Nation-wide Cooperative Research Projects

The Institute has a long history of fundamental contributions in many fields of engineering and science that include the fields of semiconductor materials and devices, magnetic recording, optical communication, electromagnetic technology, applications of ultrasonics, acoustic communication, non-linear physics and engineering, and computer software. On the basis of this rich historical background the Institute was designated as National Center for Cooperative Research in 1994. Accompanying Tohoku University's transformation to "a national university juridical entity" in April, 2004, this institution plays a leading role on the world stage, as its researchers, both domestic and foreign, continue the task of "investigating the theory and application of universal science and technology to realize communication, to the enrichment of humanity."

In such background, the Institute organizes Nation-wide Cooperative Research Projects by coordinating its activities with research workers. The main themes for Cooperative Research are selected annually by the Committee for Cooperative Research. Then invitations for project proposals and participation are extended to university faculties and government laboratories as well as industrial research groups. Each project approved by the Faculty Council of the Institute is carried out by a team of researchers that include members of the Institute as well as outside participants.

The Advisory Council which includes members from other institutions has an advisory function to the Director in defining the general direction of the research at the Institute and its Nation-wide Cooperative Research Projects.

The Project Judging Committee that includes members from the outside of Tohoku University has a judging function for project proposals. The purpose of the Project Steering Committee is the proper operation of approved projects.

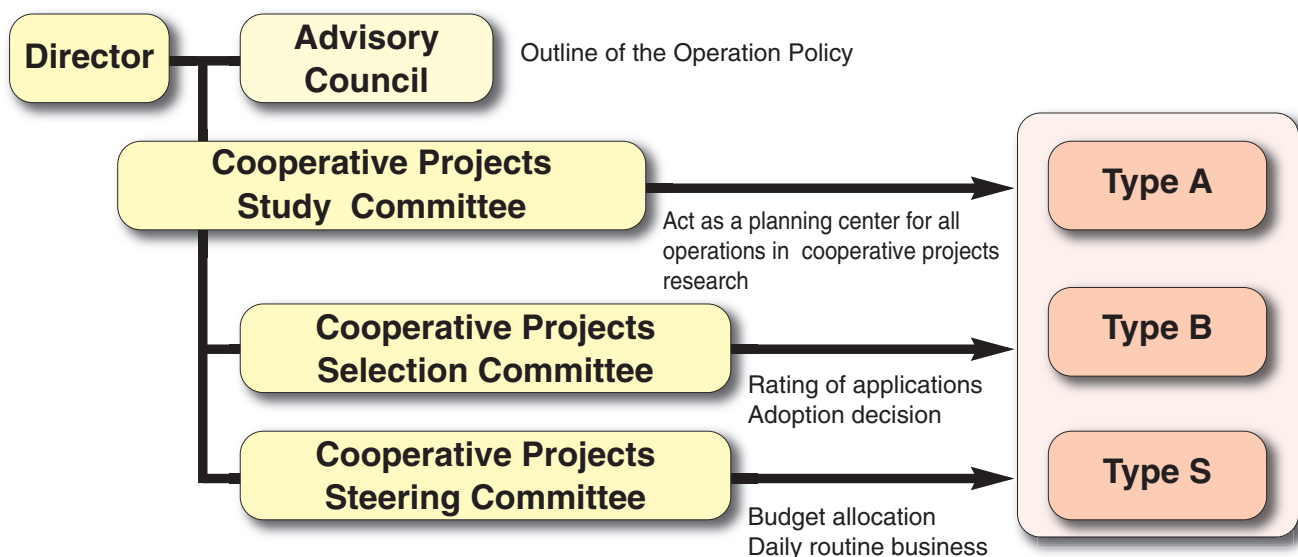

Research Fields

The Research Institute of Electrical Communication (RIEC) maintains a close cooperative relationship with the Graduate Schools of Engineering, Information Sciences and Biomedical Engineering in its research and educational activities, especially with the Departments of Electrical and Communication Engineering, Electronics, Computer and Mathematical Science, System Information Science and Applied Information Sciences. This cooperation enriches the research activities of RIEC as a "Joint Usage / Research Center." The research fields of four divisions are:

- (1) Information Devices Division: Advanced Nano-Information Devices Utilizing Physical Phenomena
- (2) Broadband Engineering Division: Next Generation Systems for Ultra-Broadband Communication
- (3) Human Information Systems Division: Creation of Information Systems Harmonizing People and Environments
- (4) Systems & Software Division: Advanced System and Software for Information Society

Information Devices Division

Materials Science and Device Science

- Solid State Electronics
- Dielectric Nano-Devices
- Materials Functionality Design
- Atomically Controlled Processing
- Physical Fluctuomatics *
- Intelligent Integrated Systems *
- Advanced Management of Integrated System Technology *
- Solid State Electronics *
- Physical Acoustics *

Electronic and Optical Quantum Science

- Nano-Photoelectronics
- Quantum-Optical Information Technology
- Biomodeling *

Plasma Science

- Electromagnetic Theory *
- Magneto-Plasma-Dynamic Engineering *

Visitor Section

- Magnetic Devices

Broadband Engineering Division

Information Technology

- Advanced Wireless Information Technology
- Technology Development Division Mobile Wireless Technology Group
- Ultrasonic Micro-Spectroscopy *

Ultrahigh-Frequency Engineering

- Ultra-Broadband Signal Processing
- Communication Engineering *

Optical Communication / Applied Quantum Electronics

- Ultrahigh-Speed Optical Communication
- Applied Quantum Optics
- Optical Physics Engineering *
- Neural Electronic Engineering *
- Information Measurement and processing *

Information Recording / Material Science

- Semiconductor Spintronics
- Information Storage Systems
- Technology Development Division Storage Technology Group
- Nano-Spin Memory
- Microelectronics *
- Electronic Physics Engineering *
- Algorithm Theory *
- Nanoscale Magnetism and devices *
- Medical Nanosystem Engineering *
- Spin Electronics *
- Magnetic Materials *
- Nano Intelligent System *

Visitor Section

- Basic Technology for Broadband Communication

Human Information Systems Division

Bioinformation

- Electromagnetic Bioinformation Engineering
- Electromagnetic Theory *
- Applied Power Systems Engineering *

Human Information Processing

- Advanced Acoustic Information Systems
- Visual Cognition and Systems
- Intelligent Communication Network *
- Electronic Control Systems *
- Advanced Information Technology *
- Electronic Control Engineering *

Communication Environment

- Ubiquitous Communication Systems
- Electromagnetic Wave Engineering *

Bioelectronics

- Nano-Molecular Devices
- Basic Plasma Engineering *
- Biomedical Electronics *
- Nano-Biomedical Engineering *
- Systems Bioinformatics *

Real World Computing

- Real-World Computing
- Bio-electromagnetics *

Visitor Section

- Multimodal Computing

Systems & Software Division

Computer Science

- Software Construction
- Computing Information Theory
- Foundations of Software Science *
- Intelligent Systems Science *
- Information Security *
- Image Information Communications *

Internet Communication

- Communication Network
- Information Contents
- Information Network System *
- Information Technology *
- Electric Energy System Engineering *
- Applied Intelligence Software *
- Communication Science *
- Creation Understanding and Distribution Technology for Digital Content *

VLSI System

- Intelligent Nano-Integration System
- New Paradigm VLSI System
- Microarchitecture
- Intelligent Electronic Circuits *
- Power Electronics *
- Computer Structures *

Visitor Section

- Information Social Structure

*Laboratories in Graduate Schools

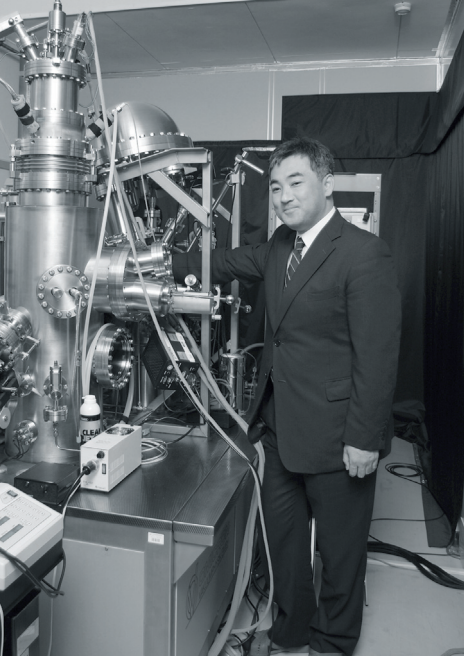

Nano-Photoelectronics



*Materials Functionality
Design*

*Quantum-Optical
Information Technology*



Information Devices Division

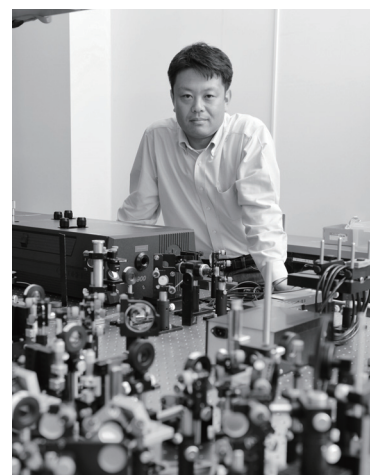
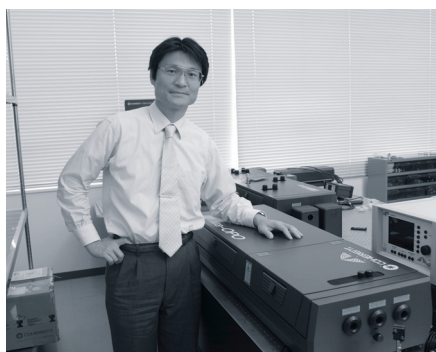

Solid State Electronics



*Dielectric
Nano-Devices*

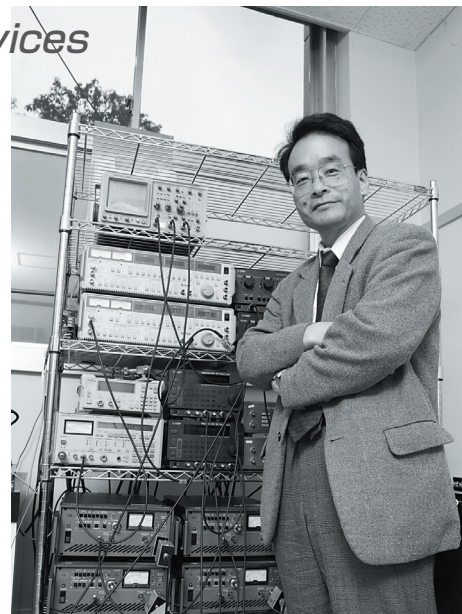

Nano-photoelectronics

Staff:

Yoichi UEHARA, Professor

Satoshi KATANO, Assistant Professor

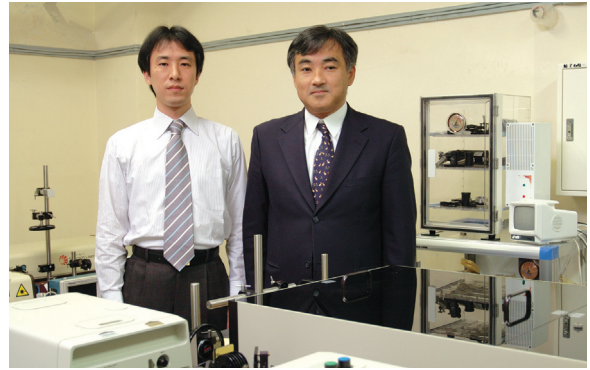

S. KATANO

Y. UEHARA

Research activities:

Our main interest lies in studying the physical and chemical phenomena that take place in nanometer-scale regions and their applications in nanophotonic devices. Development of novel probing methods is also targeted.

Nono-photoelectronics (Prof. UEHARA)

The material properties of individual nanostructures are investigated through their optical responses to the local excitation induced by electron tunneling in a scanning probe microscope (SPM). In this method, unlike conventional electric measurements, attainable temporal resolution is not limited by the signal levels. Hence, the material properties are explored with high spatial and temporal resolution. Efficient excitation of light confined in nanostructures is possible in the spectral range from THz to PHz by electron tunneling. This confined light is efficiently converted to free (i.e., propagating) light by the presence of the tip. By utilizing such properties, one can realize efficient and broad-band optical sources and detectors.

Research topics:

1. Investigation of material properties of individual solid nano-structures, e.g., determination of life times of phonons confined in nanostructures.
2. Investigation of material properties of individual surface adsorbed molecules, e.g., vibrational spectroscopy of individual single molecules.
3. Investigation of various electromagnetic phenomena in nanometer-scale spaces, and their applications to engineering.
4. Development of efficient and broad-band optical sources and detectors.

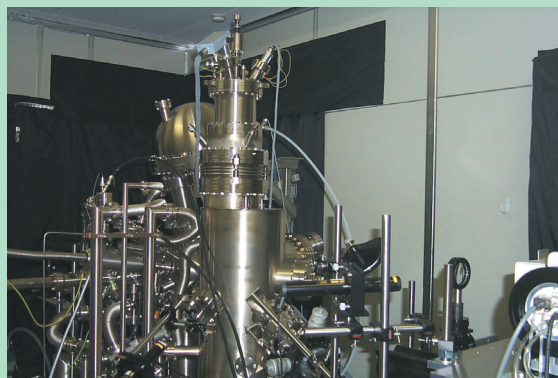

Integrated Surface Analysis System with Low-temperature STM

Quantum-Optical Information Technology

Staff:

Keiichi EDAMATSU, Professor

Hideo KOSAKA, Associate Professor

Yasuyoshi MITSUMORI, Associate professor

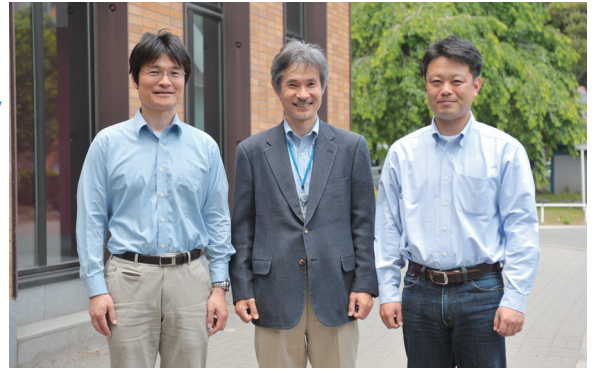

H. KOSAKA K. EDAMATSU Y. MITSUMORI

Research activities:

Current information and communication technology utilizes macroscopic and classical physical quantities, such as voltage or frequency of electric fields. The classical technology will reach the limit of information density and speed in the near future. The quantum-mechanical counterpart, “quantum information processing and communication technology,” in which information is carried by microscopic and quantum-mechanical quantities, is expected to overcome the difficulty. Our goal is to develop the quantum information devices utilizing quantum interaction between electrons and photons in semiconductor nanostructures, to obtain further understanding of their physics, and to apply them to practical quantum information technologies.

Quantum-Optical Information Technology (Prof. EDAMATSU)

Development of fundamental devices of quantum info-communication technology (QICT) utilizing photons, novel materials and semiconductor nanostructures.

Research topics:

1. Novel techniques for the generation and detection of photon entanglement.
2. QICT devices using optical fibers, waveguides, and semiconductor nanostructures.

Quantum Solid State Physics (Assoc. Prof. KOSAKA)

Development of quantum interfaces essential for QICT based on particle-wave duality of a quantum through the deep understanding of interaction between electrons and photons.

Research topics:

3. Quantum media conversion between a photon and an electron spin and its entanglement-based application.
4. Development of quantum repeaters with an electron spin and nuclear spins in quantum dots and diamonds.

Quantum Laser Spectroscopy (Assoc. Prof. MITSUMORI)

Development of optical manipulation technique of electrons in semiconductor quantum structures for the realization of QICT.

Research topics:

5. Coherent optical control of an electron in a semiconductor quantum dot.
6. Quantum optics of semiconductor microcavities.

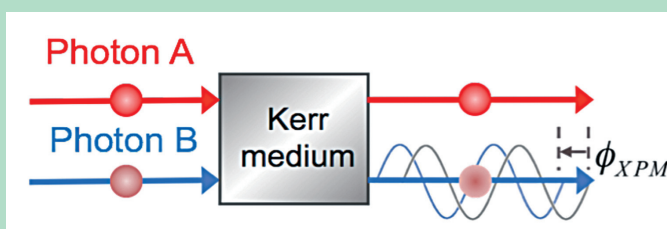

Fig. 1 Single-photon-level optical nonlinearity in optical fibers and waveguides.

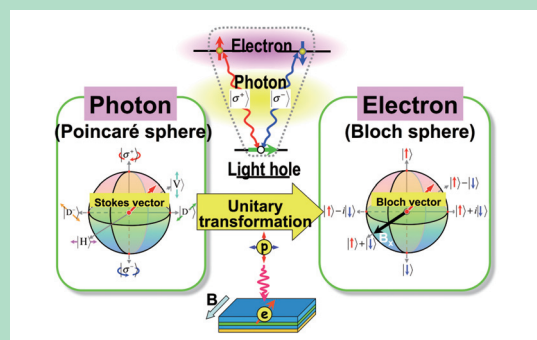

Fig. 2 Quantum media conversion from photon polarization to an electron spin.

Solid State Electronics

Staff:

Maki SUEMITSU, Professor

Hirokazu FUKIDOME, Assistant Professor

Hiroyuki KAGESHIMA, Visiting Professor

Sergey FILIMONOV, Visiting Associate Professor

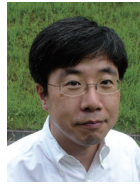

H. KAGESHIMA

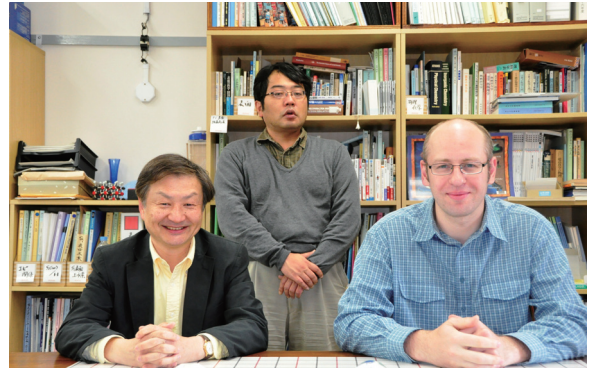

M. SUEMITSU

H. FUKIDOME

S. FILIMONOV

Research activities:

To realize the ubiquitous (or the ambient intelligence) society, in which sensors and their networks are embedded in our ambience to support our daily life through prompt warnings of various environmental crises, a marriage between non-Si technologies suitable for environmental sensing and the Si technology suitable for signal processing is indispensable. To this goal, we investigate formation of ultrathin silicon-carbide (SiC) films on Si substrates, hoping to use them as a common interface between the two technologies. We have especially succeeded in the formation of epitaxial graphene on Si substrates for the first time via graphitization of an ultrathin SiC/Si layer, thereby leading the world in this area.

Solid-State Electronics (Prof. SUEMITSU)

SiC is a compound semiconductor that contains a pair of group-IV elements that represents conventional (Si) and bio- and nanocarbon-based (C) electronics. It also bridges the gap between Si and other II-VI or III-V compounds. SiC is a widegap semiconductor that enables high-temperature operations. High enough strength and hardness of SiC make this material suitable for use in MEMS structures. We are investigating growth of SiC ultrathin film on Si substrates, by developing a single-precursor-based gas-source molecular-beam epitaxy. The research covers from clarifying the growth kinetics to fabrication of electronic devices based on the structure.

By simply annealing the SiC/Si ultrathin film in ultrahigh vacuum, we can epitaxially grow a few layers of graphene on top of the Si substrate. Graphene is a two-dimensional honeycomb network of C atoms, in which electrons and holes can run at a speed that is ~100 times higher than that in Si. This is why graphene is called a dream material. Our research includes clarifying and controlling the surface chemistry needed to fabricate the nanostructures on Si and SiC surfaces, which are all integrated into fabrication of qualified graphene on silicon substrates. We are developing electronic devices centered on high-speed devices using this graphene-on-silicon technology.

Research topics:

1. Surface chemistry during formation of SiC films on Si substrates
2. Surface chemistry during the graphene-on-Si process
3. High-speed devices based on the graphene-on-Si structure
4. Material processing using normal-pressure plasma-enhanced chemical vapor deposition

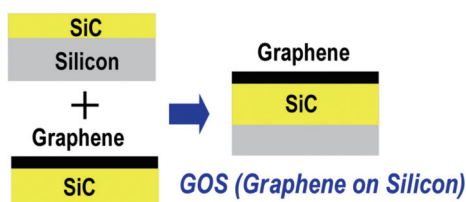

The world-first graphene-on-silicon technology

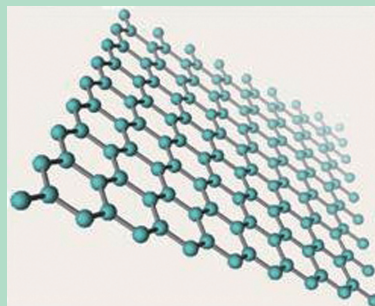

Graphene: A two-dimensional network of carbon atoms

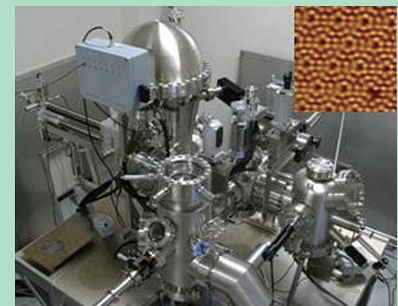

A UHV-compatible process/analyses system and the STM image of a Si surface (inset).

Dielectric Nano-Devices

Staff:

Yasuo CHO, Professor

Yoshiomi HIRANAGA, Assistant Professor

Kohei YAMASUE, Assistant Professor

Yasuo WAGATSUMA, Technical Official

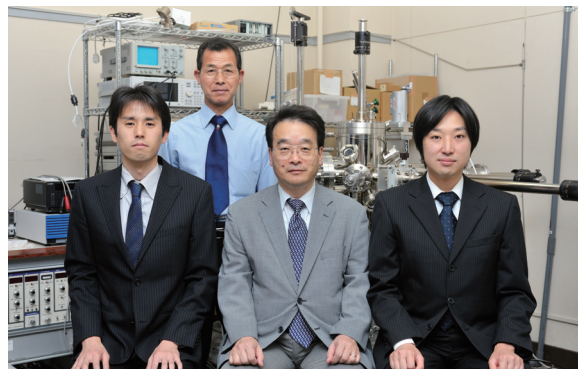

Y. WAGATSUMA
K. YAMASUE Y. CHO Y. HIRANAGA

Research activities:

The aim and target of the dielectric nano-devices laboratory are developing the research on the dielectric measurement of electronic materials using nano-technologies and applying its fruits to high-performance next generation electronic devices. It is also very important aim of our laboratory to bring up leaders of the next generation by cultivating young researchers and students through the research activities.

Dielectric Nano-Devices (Prof. CHO)

Our main area of interest is evaluation and development of dielectric materials, including ferroelectric and piezoelectric materials and their application to communication devices and ferroelectric data storage systems.

Our measure contributions to advancement in these fields are the invention and the development of "Scanning Nonlinear Dielectric Microscope" (SNDM) which is the first successful purely electrical method for observing the ferroelectric polarization distribution without the influence of the shielding effect by free charges and it has already been put into practical use. The resolution of the microscope has been improved up to atomic scale-order. Therefore, it has a great potential for realizing the ultra-high density ferroelectric recording system. Our recent research achieved to fabricate an ultra-small domain inversion dot, which has the diameter of 3 nm in case of single dot fabrication, and achieved the recording density of 4 Tbit/inch² in actual information storage, requiring an abundance of bits to be packed together.(Fig.3)

Moreover, we have started to make a measurement and an evaluation of flash-memory device and dopant profile in semiconductor devices using SNDM. Because SNDM can detect very small capacitance variation, it can be a very powerful evaluation tool for various materials. Now SNDM evolves into a new evaluation technique for insulator material and semiconductor materials besides ferroelectric materials.

Research topics:

1. Development of scanning nonlinear dielectric microscope (SNDM) with super high (atomic-scale) resolution.
2. Ultra-high density ferroelectric recording system using SNDM.
3. Development of ferroelectric functional devices for electrical communications using nano-domain engineering based on SNDM.
4. Evaluation of ferroelectric material and piezoelectric material using SNDM.
5. Evaluation of flash-memory device and dopant profile in semiconductor devices using SNDM



Commercially available scanning nonlinear dielectric microscope.

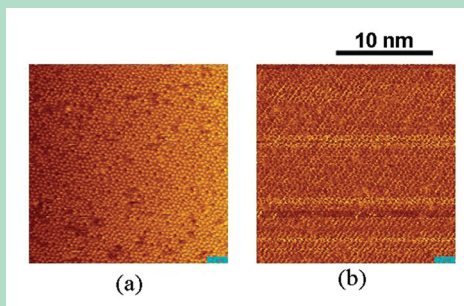

S(111) 7X7 atomic structure taken by SNDM. (a)Topography (b) Electric dipole-moment.

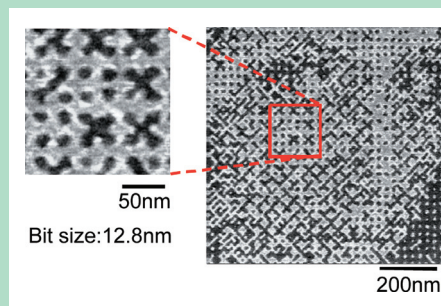

Example of a ferroelectric actual information storage (4 Tbit/inch²).

Materials Functionality Design

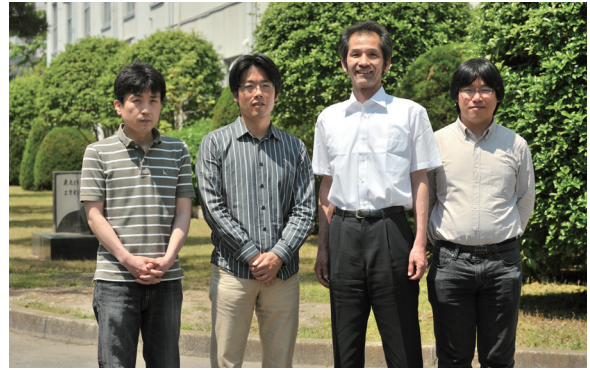

K. ABE Y. MIURA M. SHIRAI M. TSUJIKAWA

Staff:

Masafumi SHIRAI, Professor
Yoshio MIURA, Assistant Professor
Kazutaka ABE, Assistant Professor
Masahito TSUJIKAWA, Research Fellow

Research activities:

Various kinds of materials, such as semiconductors, dielectrics, and magnets, are utilized for processing, communication, and storage of massive data in the modern information-oriented society. Our research objectives are as follows: (1) theoretical analyses of quantum phenomena which appear in materials and nanostructures for advanced information devices, (2) computational design of materials and nanostructures which possess new functionalities for improvement of device performance, and (3) development of epoch-making materials and functionality design procedures on the basis of large-scale computational simulation techniques.

Materials Functionality Design (Prof. Shirai)

Our research interest is focused on “spintronics”, an interdisciplinary research field emerging from materials science, physics, electronics, and magnetism, where both charge and spin degrees of freedom are exploited to realize new kinds of advanced information devices. The main research topics are computational design of new spin-related functionalities exhibited in the highly spin-polarized materials and device-structures utilizing the materials. Recently, we focus our research objectives on the computational design of efficient spin sources for injecting spin-polarized currents into non-magnetic metals and semiconductors.

We successfully proposed the hetero-junctions which preserve high spin polarization even at the interfaces between half metals and non-magnetic materials [Y. Miura, *et al.*, Phys. Rev. B 78, 064416 (2008)]. We elucidated the effects of atomic disorder and/or thermal fluctuation of spin configurations on spin-dependent transport properties.

Research topics:

1. Computational design of new spintronics materials from first-principles
2. Computational analysis of transport properties in spintronics devices
3. Computational simulation of nanostructure-growth process on surface
4. Development of computational scheme for material/device design

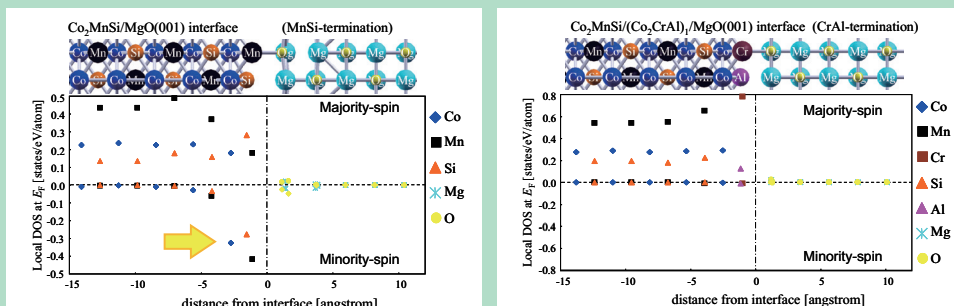

We theoretically proposed that a highly spin-polarized interface can be realized by inserting a thin Co_2CrAl layer (right panel) into a $\text{Co}_2\text{MnSi}/\text{MgO}$ (001) junction (left panel).



*Ultrahigh-Speed Optical
Communication*



Broadband Engineering Division

Wireless Info Tech



*Applied
Quantum Optics*



Information Storage Systems

Ultra-Broadband Signal Processing



Basic Technology for Broadband Communication (Visitor Section)

Ultrahigh-Speed Optical Communication

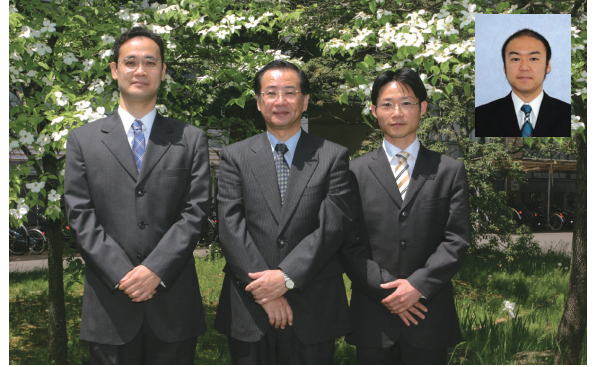

T. HIROOKA M. NAKAZAWA M. YOSHIDA K. KASAI

Staff:

Masataka NAKAZAWA, Professor

Toshihiko HIROOKA, Associate Professor

Masato YOSHIDA, Associate Professor

Keisuke KASAI, Research Fellow

Research activities:

With the vast growth of traffic on the Internet from simple text data to high quality voice, image, and real-time video content, it has become increasingly important to realize an ultrafast, high-capacity network to support the daily needs of modern communications. Ultrahigh-speed optical communication is the key technology for building such an interconnected world. This laboratory aims to realize a global ultrahigh-speed optical network by engaging in research on ultrashort pulse generation and transmission. Our research areas include optical solitons, high-speed mode-locked lasers, optical signal processing, and the development of fibers with new functions.

Optical Transmission (Prof. NAKAZAWA)

Ultrahigh-speed optical transmission is the driving force behind attempts to realize advanced high-speed networks that support ultrahigh-precision image transmission or ultra-realistic communication. At the same time, there is a strong need to realize spectrally efficient optical transmission to expand the transmission capacity for a given optical bandwidth. With a view to achieving an ultrahigh bit rate exceeding 1 Tbit/s/channel, we are actively engaged in realizing ultrafast optical time division multiplexed (OTDM) transmission using ultrashort pulse lasers. To expand the spectral density, we are working intensively on ultra-multi-level coherent QAM transmission technology in which the spectral efficiency is greatly improved by encoding the information in both the amplitude and phase of an optical beam. Another important aspect of our research relates to the development of photonic crystal fibers. These special fibers have many air holes in the fiber cross-section, and they have potential applications in new optical communication systems operating in the currently unused 500-1000 nm band.

Research topics:

1. Terabit/s OTDM transmission using a femtosecond pulse train
2. Ultra-multi-level coherent optical transmission toward the Shannon limit
3. Photonic crystal fibers and optical fibers with new functionality

Optical Signal Processing (Assoc. Prof. HIROOKA)

We are engaged in the development of all-optical technologies using nonlinear optical effects by taking advantage of ultrafast optical properties, where optical signals are processed without the need to convert them into the electrical domain. Specifically, we are developing femtosecond pulse compression, pulse shaping, optical demultiplexing, and distortion elimination techniques, which are indispensable for realizing ultrahigh-speed OTDM transmission exceeding terabit/s.

Research topics:

4. Distortion elimination technique using time-domain optical Fourier transformation
5. All-optical signal processing using nonlinear optical effects and their application to ultrahigh-speed OTDM transmission

High Accuracy Measurements using Optical Fibers (Assoc.Prof. YOSHIDA)

We are engaged in the development of frequency stabilized laser operated at 1.55 μm and its application to high accuracy measurements using optical fibers. Furthermore, we are developing ultra-short pulse lasers.

Research topics:

6. Frequency stabilized lasers and their application to high accuracy measurements using optical fibers
7. Ultrashort mode-locked lasers and their application to frequency standards and microwave-photonics

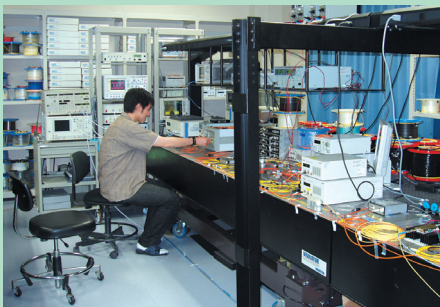

Experiment on ultrahigh-speed optical transmission

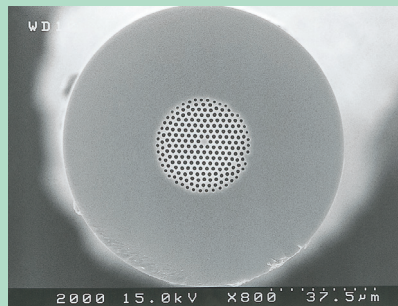

(Left photo:cleaved end face of a PCF)

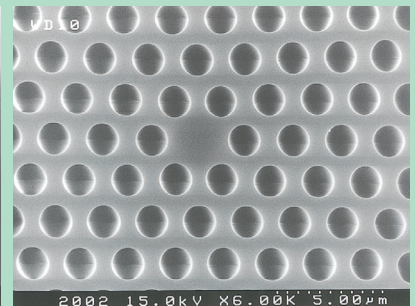

Photonic crystal fiber

(Right photo:enlarged cross section)

Applied Quantum Optics

Staff:

Hiroshi YASAKA, Professor



H. YASAKA

Research activities:

Internet traffic has been increasing explosively and the amount of information which should be processed has been increasing. The capacity of information processing in optical communication systems should be increased drastically to cope with the explosive increase in the information traffic. It is necessary to realize ultra-high speed and highly functional semiconductor photonic devices and semiconductor photonic integrated circuits to construct next generation highly functional optical information communication network systems.

We are investigating novel, highly functional semiconductor photonic devices, which is indispensable to realize new generation optical information communication network systems. Furthermore, our research interests cover ultrafast photonic devices, opto-electronic semiconductor devices and their applications to optical computing and signal processing areas.

Highly Functional Photonics (Prof. YASAKA)

It is indispensable to establish highly functional light source and photonic device technologies and novel functional semiconductor photonic integrated circuit technology for realizing highly functional optical communication systems and novel functional optical signal processing systems. We have been studying highly functional semiconductor photonic devices and semiconductor photonic integrated circuits based on semiconductor lasers and semiconductor optical modulators to create novel semiconductor photonic devices, which can control intensity, phase, frequency and polarization of optical signal freely. Furthermore we research novel semiconductor photonic functional devices based on novel principle to realize innovative photonic information communication network systems.

Research topics:

1. Ultra-high speed control of semiconductor photonic devices by signal light injection
2. Highly functional semiconductor light sources
3. Highly functional semiconductor optical modulators
4. Novel functional semiconductor photonic integrated circuits

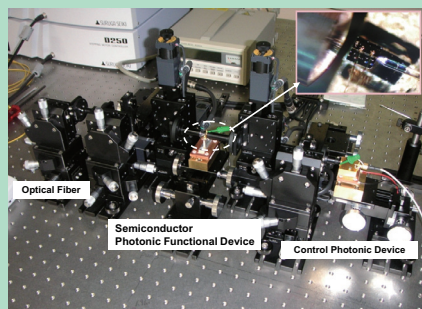

Experimental setup for high-speed operation of functional semiconductor photonic devices by external optical signal injection.

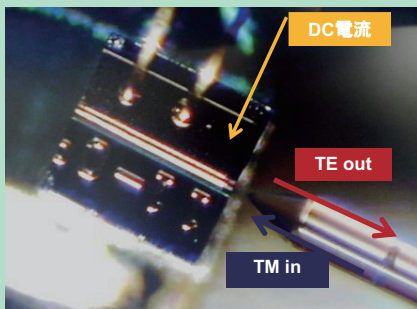

Magnified photo of a functional semiconductor photonic device.

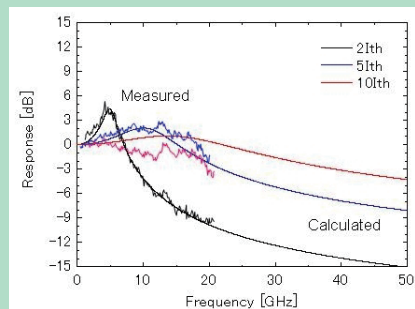

Measured and calculated response of functional semiconductor photonic device.

Advanced Wireless Information Technology

Staff:

Noriharu SUEMATSU, Professor
Suguru KAMEDA, Assistant Professor
Shoichi TANIFUJI, Research Fellow

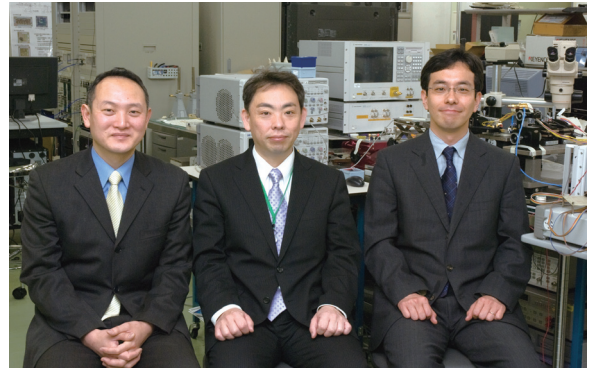

S. TANIFUJI N. SUEMATSU S. KAMEDA

Research activities:

Wireless communication systems, such as cellular phones, have offered mobile voice/mail services to us. Nowadays, they begin to offer mobile internet services which handle high capacity photo/motion data. In order to enjoy freedom from wired lines, small size, light weight, long battery life terminals have been required. For the next generation wireless systems, dependable connectivity and green wireless information technologies (IT) will be the key issues.

Advanced Wireless Information Technology (Prof. SUEMATSU)

Toward the realization of a ubiquitous and broad-band wireless network, we are actively engaged in the research work on dependable and low power consumption advanced wireless IT. We cover the whole technical fields from the lower to higher layers, i.e., signal processing, RF/Mixed signal device, antenna, MODEM and network technologies.

As the studies on signal processing, RF/Mixed signal device and antenna technologies, we are developing RF/Millimeter-wave RF CMOS IC's, antenna integrated 3-dimensional system in package (SiP) transceiver modules, digital/RF mixed signal IC's.

As the studies on MODEM and network technologies, we are focusing on next generation mobile broadband wireless access (MBWA; mobile broadband wireless access), dependable broadband wireless local area network (WLAN) and ultra-broadband wireless personal area network (W-PAN).

We are also working for the next generation wireless communication systems/devices which include a location / short message communication system via quasi-zenith satellites (QZS) and a fusion of various wireless communication systems "dependable wireless system."

Research topics:

1. Mobile broadband wireless access network
2. Broadband wireless on-chip transceivers
3. Digitally assisted RF analog circuits
4. Millimeter-wave/submillimeter-wave IC's
5. Low Power Digital RF circuits
6. Heterogeneous mobile network
7. Digital signal processing for broadband wireless communication
8. Location/Message Communication Service via QZS
9. Dependable wireless system

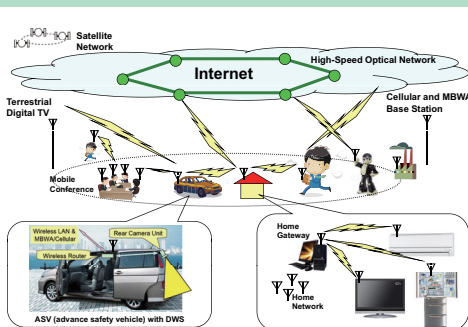

Fig.1 Evolutional network for ubiquitousness and broadband

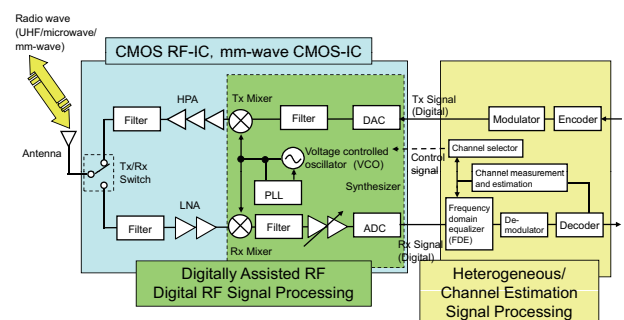

Fig.2 One-chip transceiver LSI for broadband wireless communication

Information Storage Systems

Staff:

Hiroaki MURAOKA, Professor

Simon J. GREAVES, Associate Professor

Kenji MIURA, Assistant Professor



K. MIURA

H. MURAOKA

S. J. GREAVES

Research activities:

Our main interest lies in high-density information storage technology. The core technology is magnetic recording with fast data transfer and large storage capacity, which is applied for hard disk drives, magnetic tape storage, and flexible disk drives. Recently, multi-media information such as digital movie and music that requires very large storage capacity begins to be used in broad applications from consumer electronics to mobile communication. This trend accelerates the areal density increase of magnetic recording. Recording theories, devices, and systems based on perpendicular recording are being studied in order to attain ultra-high density information storage. Our target is the terabit storage (Over 5 Tbits/inch² areal density), in which the bit size corresponds to the area of 10 nm by 10 nm.

Information Storage Systems Research Division (Profs MURAOKA, MIURA)

A single-pole head and perpendicular disks are investigated through read/write experiments, as shown in Fig 1, to improve the recording performance. For extremely large capacity storage systems, the storage grid working on a network, as shown in Fig 2, is also explored.

Research topics:

1. High areal density hard disk drives
2. Head/disk devices for high density magnetic storage
3. Digital signal processing for high density storage
4. Network storage for large capacity file server

Recording Theory Computation Research Division (Prof. GREAVES)

A computer simulation utilizing micromagnetics is being carried out to obtain a guideline towards ultra-high density recording.

Research topics:

5. Micromagnetics simulation for high density read/write theory

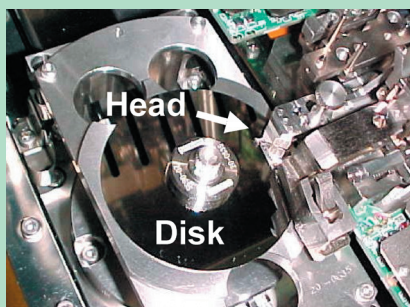

Fig 1 Read/write measurement by using a single-pole head and a perpendicular media.

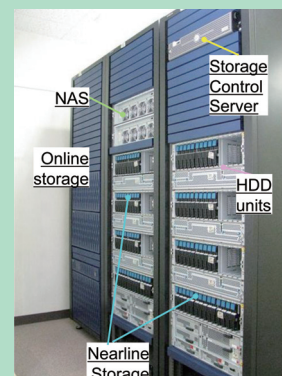

Fig 2 A large-scale storage system with parallel HDD operation.

Ultra-Broadband Signal Processing

Staff:

Taiichi OTSUJI, Professor

Tetsuya SUEMITSU, Associate Professor

Akira SATOU, Assistant Professor

Stephane Albon BOUBANGA TOMBET, Research Fellow

Susumu TAKABAYASHI, Research Fellow

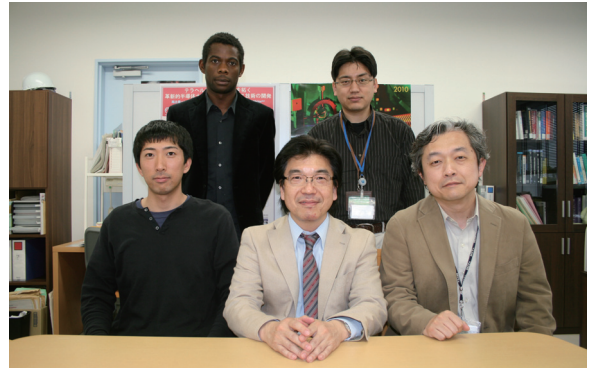

S. A. BOUBANGA TOMBET S. TAKABAYASHI
A. SATOU T. OTSUJI T. SUEMITSU

Research activities:

Terahertz (sub-millimeter) coherent electromagnetic waves are expected to explore the potential application fields of future information and communications technologies. We are developing novel, ultra-broadband integrated signal-processing devices/systems operating in the millimeter-wave and terahertz frequency regime.

Ultra-Broadband Devices and Systems (Prof. OTSUJI)

We are developing novel, integrated electron devices and circuit systems operating in the millimeter-wave and terahertz regions. One example is the frequency-tunable plasmon-resonant terahertz emitters, detectors, and modulators. Another example is unique electromagnetic metamaterial circuit systems based on optoelectronic dispersion control of low-dimensional plasmons. We are also pursuing graphene-based new materials to create new types of terahertz lasers and ultrafast transistors, breaking through the limit on conventional transistor/laser operation. By making full use of these world-leading device/circuit technologies, we are exploring future ultra-broadband wireless communication systems as well as spectroscopic/imaging systems for safety and security.

Research topics:

1. Plasmon-resonant terahertz emitters/detectors/modulators and their system applications
2. Terahertz metamaterial circuit systems based on dispersion control of low-dimensional plasmons
3. Graphene-based terahertz lasers and ultrafast transistors, and their system applications

Ultrafast Electron Devices (Assoc. Prof. SUEMITSU)

Transistors are important building blocks for integrated circuits used in a lot of systems for information and communication technologies. Particularly in optical fiber communication systems and (sub-) millimeter-wave frequency systems that require ultimately high-speed operation, the channel materials of transistors should be chosen to realize high mobility and saturation velocity for carrier electrons (or holes). In our group, we are focusing on three important material systems for such high-speed devices: the indium gallium arsenide (InGaAs) material systems for ultimately high-frequency operation including sub-millimeter-wave regime, the gallium nitride (GaN) material systems for high-power millimeter-wave applications, and the graphene-based material systems as a new candidate for high-speed devices. Our activities include the design, process, and characterization of these devices and their integrated circuits.

Research topics:

4. InGaAs- and GaN-based heterostructure field effect transistors (FETs) for ultimately high frequencies in millimeter- and terahertz-wave regime
5. Graphene-based transistors for high-speed and high-frequency applications

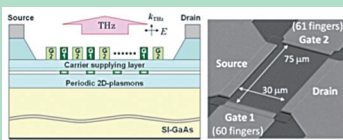

Cross-sectional view and SEM images of the plasmon-resonant emitter/detector device fabricated with GaAs-based heterostructure material systems.

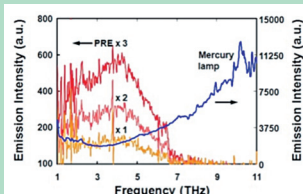

FTIR-measured broadband emission spectra of single-chip and multichip PREs in the self-oscillation mode.

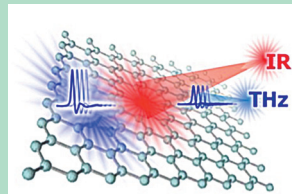

Schematic view of terahertz-wave amplification by stimulated emission utilizing population inversion in optically pumped graphene.

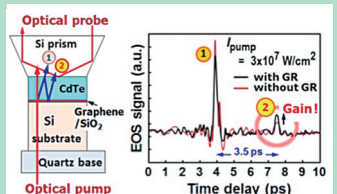

Time response of terahertz-wave amplification utilizing optically pumped graphene measured by electrooptic sampling.

Newly-proposed plasmon-resonant emitter (PRE) and graphene operating in the terahertz range.

Basic Technology for Broadband Communication

Staff:

Masaaki INUTAKE, Visiting Professor



Y. KOGI
(Fukuoka
Inst.Tech)

M. INUTAKE

H. IKEZI
(Kyushu
univ.)

J. MASE
(Kyushu
univ.)

Research activities:

Our main interest is to develop an air-borne synthetic aperture radar (SAR) for the civilian applications. The SAR is very useful for all-weather surveillance and rescue in disastrous fires and smokes. Scientists and engineers from both universities and industries collaborate on this research project.

Development of a high resolution (10cm), small size and light weight (25kg) SAR at Ku-band has been started in 2009 under the contract of Ministry of Land, Infrastructure, Transport and Tourism.

Conceptual design of a real-time image-formation SAR system has been done, as shown in the figure. A waveform synthesizer circuit with capability of precisely setting delay time has been developed in 2009. This is prerequisite for a real-time image formation.

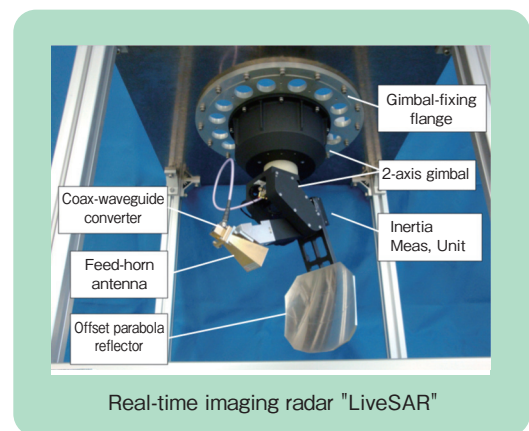

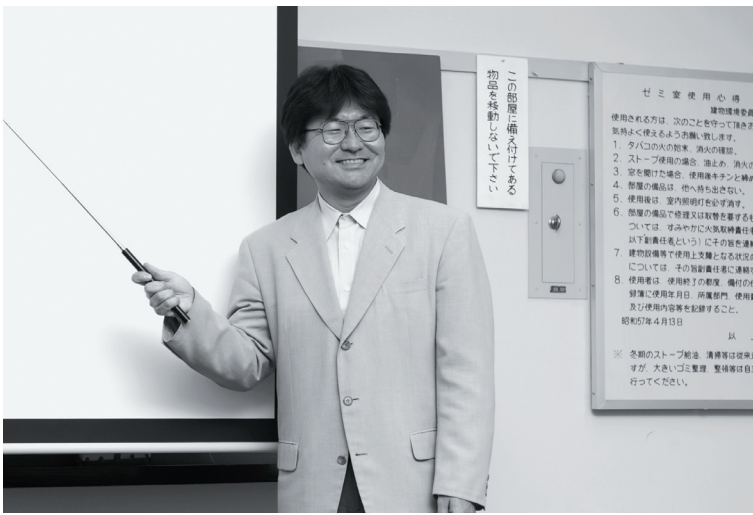

*Electromagnetic Bioinformation
Engineering*



Human Information Systems Division

*Advanced Acoustic
Information Systems*

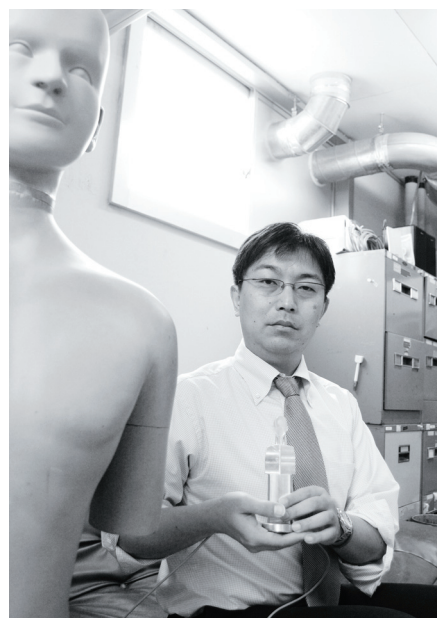

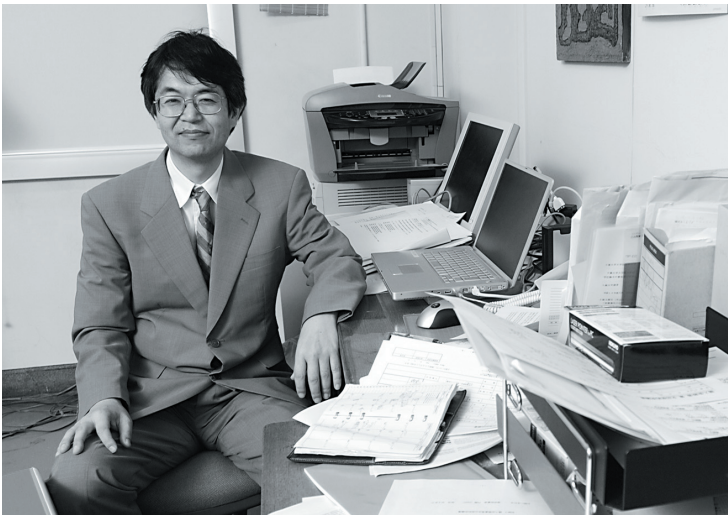

*Visual Cognition and
Systems*



*Ubiquitous
Communications System*



Electromagnetic Bioinformation Engineering

Staff:

Kazushi ISHIYAMA, Professor

Shuichiro HASHI, Associate Professor

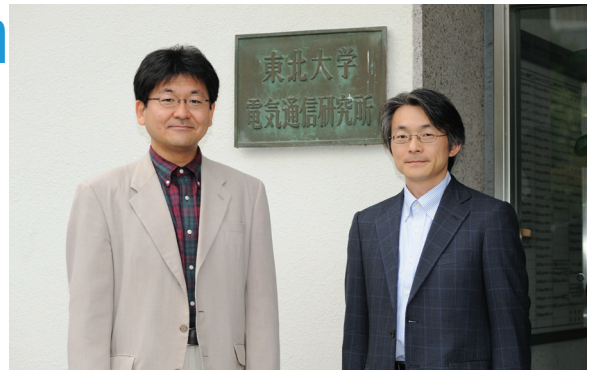

K. ISHIYAMA

S. HASHI

Research activities:

For realizing good communication with human body, and for realizing the properties of the human body as an information system, we have to realize the function of the human body as information in addition to catch the signals from the human body. Our research division works on the technology for sensing the information from the human body and for approaching action to the human body. We are focusing to realize the communication technology with human body and to contribute information and communication systems and medical-welfare spheres.

Electromagnetic Bioinformation Engineering (Prof. ISHIYAMA)

High-frequency carrier-type magnetic field sensor, which is developed in our laboratory, obtains the world-highest field sensitivity in room temperature under the works for materials, micro-fabrication techniques, controlling the magnetic properties. This sensor is studied for sensing system for bio-information. As one of the approaching system for human body, wireless actuators and manipulators are investigated. This technology is important for a basic study for robots working in the human body. A part of this technology is applied for a motion system for a capsule endoscope working in the colon tube.

Research topics:

1. Super high sensitivity magnetic field sensor
2. High-frequency electromagnetic measuring system
3. Micro magnetic actuator
4. New medical equipment using magnetic

Electromagnetic Bioinformation Materials (Assoc. Prof. HASHI)

Stressless and painless acquisition technique for accurately capturing the motion or the information of a human body is strongly desired in the area of the medical treatment and/or rehabilitation therapy. In this research division, sensing systems for temperature and for hardness are studied as no contact sensing systems. In addition, wireless magnetic motion capture system is studied for the medical and welfare use.

Development of functional magnetic materials and its fabrication process are also studied to progress these magnetic sensing systems.

Research topics:

5. Wireless magnetic sensing system
6. Functional magnetic materials

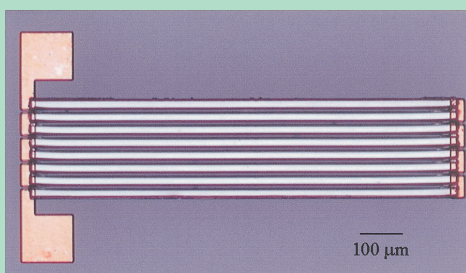

High frequency carrier-type thin film magnetic field sensor

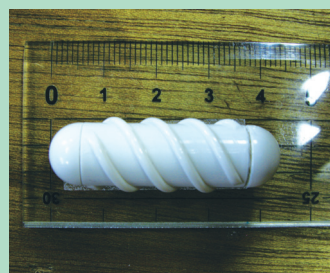

A prototype for motion of capsule-endoscope

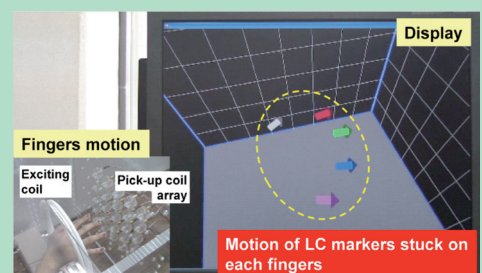

Wireless magnetic motion capture system

Advanced Acoustic Information Systems

Staff:

Yôiti SUZUKI, Professor

Shuichi SAKAMOTO, Associate Professor

Takuma OKAMOTO, Research Fellow

Hiroshi, SHIBATA, Research Fellow

Yukio IWAYA, Associate Professor

Fumitaka SAITO, Technical Official

Zhenglie CUI, Research Fellow

Akio, HONDA, Research Fellow

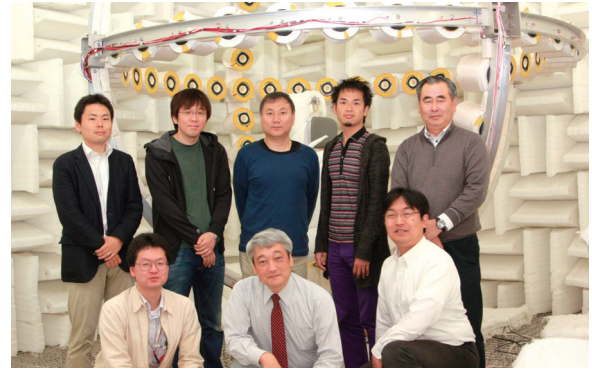

H. SHIBATA A. HONDA Z. CUI T. OKAMOTO F. SAITO
S. SAKAMOTO Y. SUZUKI Y. IWAYA

Research activities:

We are aiming at developing advanced and comfortable acoustic communications systems exploiting digital signal processing techniques. Moreover, to realize this, we are also keenly studying the information processing in the human auditory system and multimodal information processing including hearing. We mainly apply psycho-acoustical approaches to study human auditory and multimodal perception.

Advanced Acoustic Information Systems (Prof. SUZUKI)

With good knowledge of the human auditory and other perceptual systems, we are aiming at the realization of a 'comfortable' sound environment; development of three-dimensional auditory displays is a typical example. These systems are keenly required to realize the multimedia universal communications.

Research topics:

1. Auditory and multimodal information processing.
2. System theory of spatial information processing.
3. Development of new theories of acoustic digital signal processing.

Acoustic Information Communications (Assoc. Prof. IWAYA)

A lot of efforts are put to realize 3D sound space communication systems based on the system construction theory and knowledge of spatial hearing. Based on these systems, future principles for communications with a high sense of presence are keenly studied.

Research topics:

4. Spatial hearing communication systems.
5. Multimodal sound space communications.

Auditory and Multisensory Information Systems (Assoc. Prof. SAKAMOTO)

The knowledge of multisensory information processing is crucial to develop advanced information systems. We are studying the mechanism of this processing and applying to the auditory information systems.

Research topics:

6. Mechanism of multisensory information processing including hearing.
7. Auditory information systems based on multisensory information processing.



Accurate sound space communication system based on higher order Ambisonics by using 157ch speaker array

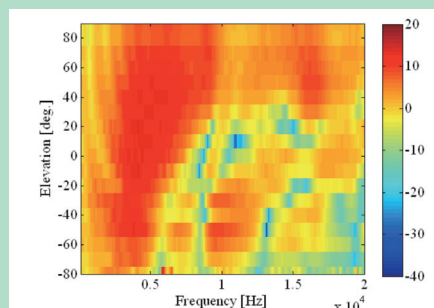

Head related transfer functions as a function of elevation. Poles and zeros change systematically with the rise of elevation.

Visual Cognition and Systems

Staff:

Satoshi SHIOIRI, Professor
Ichiro KURIKI, Associate Professor
Rumi TOKUNAGA, Assistant Professor
Kazumichi MATSUMIYA, Assistant Professor
Mitsuharu OGIYA, Research Fellow
Kazuya MATSUBARA, Research Fellow
Ryoichi NAKASHIMA, Research Fellow

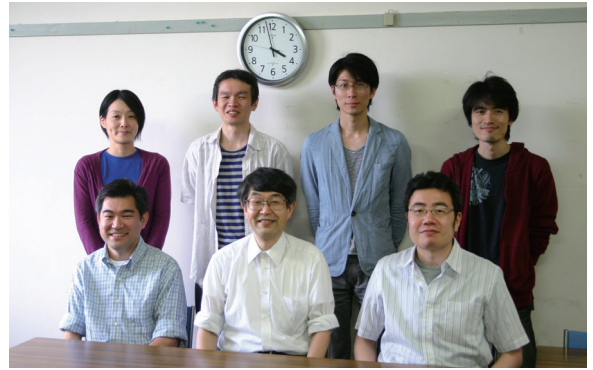

R. TOKUNAGA M. OGIYA R. NAKASHIMA K. MATSUBARA
 I. KURIKI S. SHIOIRI K. MATSUMIYA

Research activities:

Human brain is one of the most adaptable systems in the world. Understanding the brain functions is one of the most important issues for evaluating and designing things around us to improve the quality of life. We investigate the brain through visual functions to apply the knowledge to human engineering and image engineering. Our approaches include psychophysics, brain activity measurements, and computer simulations. Our research field covers visual spatial perception, 3D perception, color vision, visual attention and visual-haptic integration.

Visual Cognition and Systems (Prof. SHIOIRI)

Modeling the processes of human vision based on the findings of the strategies that the visual system uses, we plan to propose appropriate methods for evaluation of image qualities, efficient way of image presentation and evaluation of visual environments in general. We also investigate dynamic selection process in vision with or without attention to realize prediction system of human perception and action in the future.

Research topics:

1. Measurements of spatial and temporal characteristics of visual attention.
2. Modeling control system of eye movements and visual attention
3. Investigation of early, middle and late vision of 3D perception.

Cognitive Brain Functions (Assoc. Prof. KURIKI)

Our perceptual experience arises from neural activities in the brain. Studies of these neural activities are critical for understanding the mechanisms of visual perception. Moreover, presenting visual information in order that the visual information is suitably represented in the brain can provide the way to display proper visual information in information and communication technology. Here we investigate the brain functions of visual perception (mainly on color perception) using brain-activity measurement and analysis in relation to visual perception.

Research topics:

4. Representation of color information in human brain
5. Separation and integration of visual information in human brain

Independent measurements of attended and fixated points. An oversight and a mistake can cause a serious accident under the situation that you drive a car. For example, investigating the relationship between gaze and attention can provide a new insight into this problem.

Representation of visual information in the early stage of human visual cortex is still unknown. The mechanisms of visual information processing will be investigated by using behavioral studies and functional brain-imaging studies. This study may reveal the "optimal coding method" of the visual information for human brain.

How does the perceptual system integrate visual and haptic information in motion processing? We compared the magnitude of visual motion aftereffect in the haptic movement condition with that in the no haptic movement condition. This study may reveal the mechanism underlying visual-haptic integration in motion processing.

Ubiquitous Communications System

Staff:

Shuzo KATO, Professor

Hiroyuki NAKASE, Associate Professor

Hirokazu SAWADA, Assistant Professor



H. SAWADA

S. KATO

H. NAKASE

Research activities:

To realize the communications environments in which everybody can communicate without paying much attention to the tools, the Laboratory has been focusing on the core technologies and applications of 60 GHz Super Broad Band Wireless Communications in which people can communicate at the speed of multi-Gbps freely. These includes propagation, antennas, RF devices, modem, FEC, MAC, up to system design. Also, the Laboratory has been promoting Japanese technologies to be standardized at IEEE802 Standardization, and has contributed in leading the standardization as Vice Chair (acting Chair) and Chair of the global Consortium.

Ubiquitous Communications System (Prof. KATO)

To solve the key issue of millimeter wave communication systems that is reliability, the laboratory has carried out researches on (1) beam forming antenna with discrete phase shifters (90 degree resolution) and has successfully developed close-to-commercial level double slot antennas (patent pending) (Fig.1), and (2) high reliability communications systems deploying artificially installed reflectors that resulted in reducing the communications interruption probability by a factor of 10.

Furthermore, researches have been carried out on low power consumption FEC and modems as well as applications of millimeter wave communications such as wireless harness communications systems that deploy metalized hoses to reduce weight of automobile harness and increase the reliability.

Ubiquitous Communications Device (Assoc. Prof. NAKASE)

A 20% power added efficiency has been targeted for the 60 GHz CMOS amplifiers used for beam forming antenna systems by deploying "Cascode driver and Class-B source ground" amplifiers (Fig.3). Also 60 GHz phase shifters have been studied.

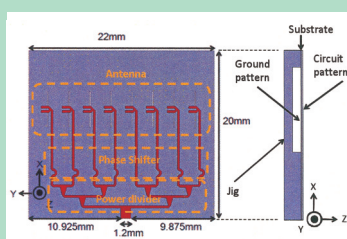

Fig. 1 Double slot beam forming antenna (top) and its directivity (bottom)

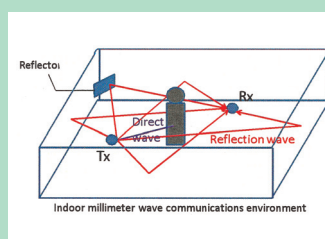
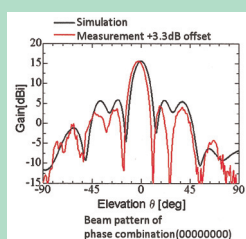

Fig. 2 Image of interruption reduction by deploying reflectors

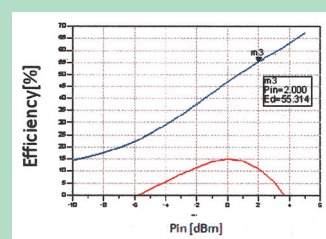
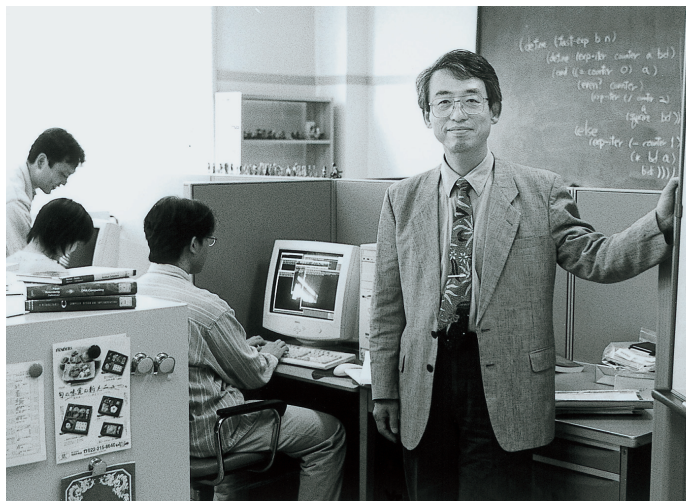

Fig. 3 Drain efficiency of 60 GHz source ground PA



Software Construction

Systems & Software Division



*Computing Information
Theory*

*Communication Network
Systems*



Information Content

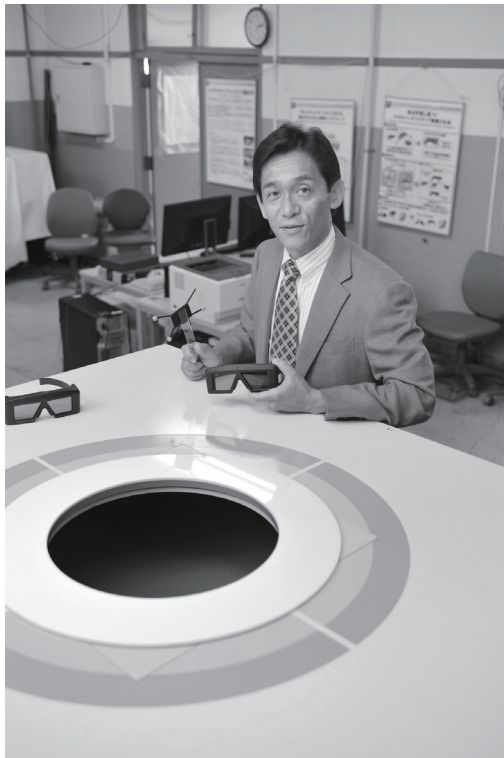

Information Social Structure (Visitor Section)

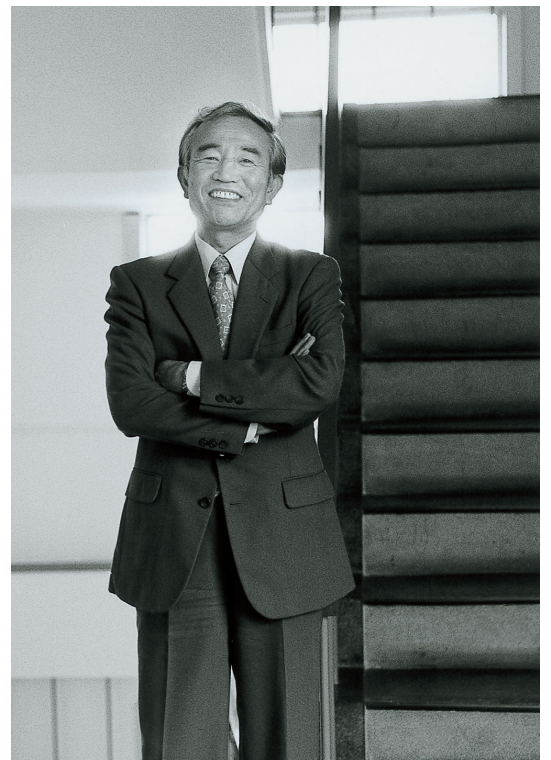

Software Construction

Staff:

Atsushi OHORI, Professor

Katsuhiko UENO, Assistant Professor

Akimasa MORIHATA, Assistant Professor



A. MORIHATA

A. OHORI

K. UENO

Research activities:

Nowadays, a variety of software systems manage everything in the world. Therefore, firm foundations for developing high performance and highly reliable software are essential for continuous advance of our societies.

We are studying foundation of software. We mainly focus on programming languages and database systems, which provide bases of software developments and data managements, respectively. The major research issues include fundamental theories for reliable software, design of productive and reliable programming languages, implementation techniques for high performance software, and software development frameworks that enable seamless integration of a variety of resources, such as programming languages, databases and distributed computational environments.

Software Construction (Prof. OHORI)

Today's software systems are becoming more and more complicated due to the need of integrating various computation resources available in the Internet. A key to control the complexity and to enhance the reliability of such a system is to develop a high-level programming language that can directly represent various resources and automatically detect potential inconsistencies among the components in a system.

Based on this general observation, our research aims at establishing both firm theoretical basis and implementation method for flexible yet reliable programming languages for advanced Internet computation. One direction toward this goal is to establish logical foundations for compilation. We aim at establishing a proof-theoretical framework that accounts for the entire process of compilation -- including A-normalization and code generation -- as a series of proof-transformations. Another direction is to provide systematic methods of developing efficient programs by program transformation. Programs should correspond to their formal specifications. Our approach is to extract program-development processes by rephrasing the correspondence by program transformations. In addition to those foundational researches, we are also developing a new practical ML-style programming language, SML#, that embodies some of our recent results such as record polymorphism, rank 1 polymorphism, and high-degree of interoperability with existing languages and databases.

Research topics:

1. Development of SML#, a new ML-style polymorphic programming language
2. Logical foundation for compilation
3. Integration of databases and programming languages
4. Program transformations for developing/optimizing algorithms
5. Reliable scripting languages for Web programming

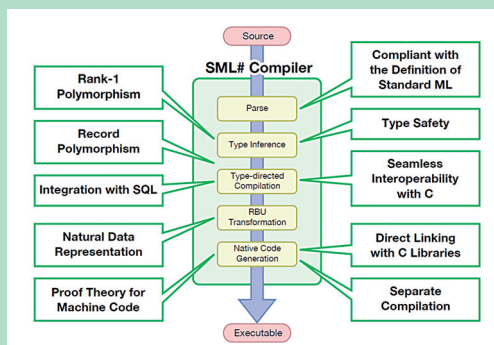

SML#, a state of the art compiler

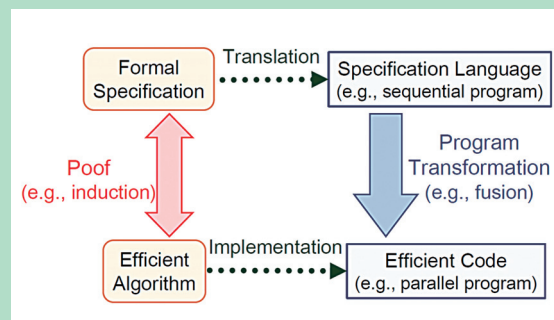

A framework for deriving algorithms by program transformations

Computing Information Theory

Staff:

Yoshihito TOYAMA, Professor

Takahito AOTO, Associate Professor

Kentaro KIKUCHI, Assistant Professor

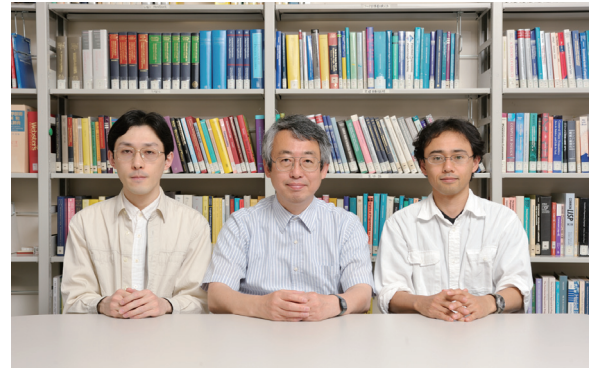

K. KIKUCHI

Y. TOYAMA

T. AOTO

Research activities:

Equational reasoning is ubiquitous in many areas of computer science such as automated theorem proving, formula manipulating systems, algebraic specifications, and functional and logic programming languages. Rewriting is a mathematical formalism which can offer both flexible computing and effective reasoning with equations. We aim at developing a unified theory of computational-logical-algebraic systems based on the theory of rewriting systems combining computations and proofs.

Computing Information Theory (Prof. TOYAMA)

Our research focuses on important theoretical features of the rewriting paradigm, such as the Church-Rosser property, the termination property, and the modular property. We are also interested in design and analysis of automated deduction systems which can offer both effective computation of functional (or logic) programming languages and flexible reasoning of automated theorem provers. We are investigating program verification and transformation systems based on automated theorem proving techniques.

Research topics:

1. Rewriting Theory
2. Foundations of Softwares
3. Automated Deduction

Computing Logical Systems (Assoc.Prof. AOTO)

We are developing techniques for verifying important properties of rewriting systems such as the Church-Rosser property and the termination property. We are also interested in proving inductive properties of rewrite systems and lemma generation methods for this. We are trying to extend these techniques to higher-order rewriting systems which are amenable for modeling more practical functional programs.

Research topics:

4. Rewrite Systems
5. Automated Theroem Proving

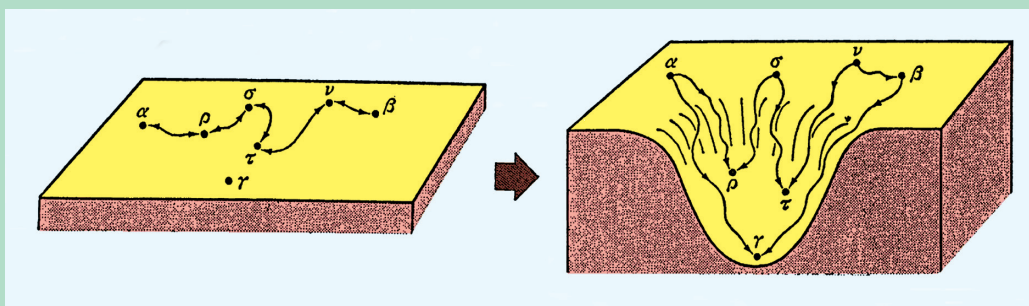

Proof by Equational Reasoning \rightarrow Computation by Rewriting Systems

Communication Network Systems

Staff:

Tetsuo KINOSHITA, Professor

Hideyuki TAKAHASHI, Assistant Professor

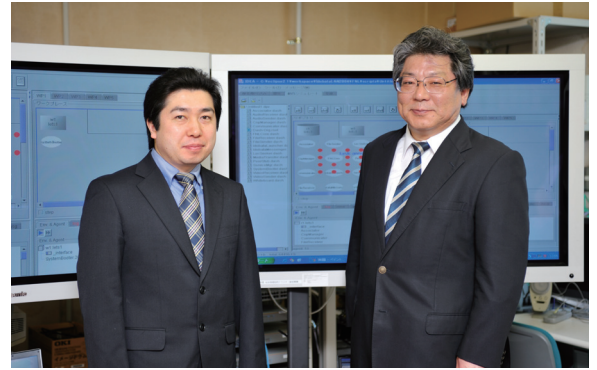

H. TAKAHASHI

T. KINOSHITA

Research activities:

Various networks exist everywhere in the society, and information systems over such networked environment support everyday life and social activities of people and create new life styles as well as information society. This laboratory aims at research and development of advanced network-based, distributed intelligent systems.

Intelligent communication (Prof. KINOSHITA)

It becomes an important problem to develop intelligent systems, which can cooperate with various people as the human-friendly, easy-to-use, intelligent partners, in order to support various creative activities of people in an active and autonomic way. To realize such an intelligent system, we propose a concept called Cyberware as an infrastructure of cybersociety that provides people a new information environment in which people and intelligent systems can work together cooperatively. We aim at studying advanced information technologies to realize a new infrastructure of cybersociety based on cooperation and coordination of both people and intelligent systems over the networked environment, using the agent based computing technologies.

Research topics:

1. Software Infrastructure of Cyber society (Cyberware)
2. Multiagent framework/Design methodology
3. Knowledge-based communication services/ User-oriented networking
4. Agent-based/Knowledge-based/Network-based systems

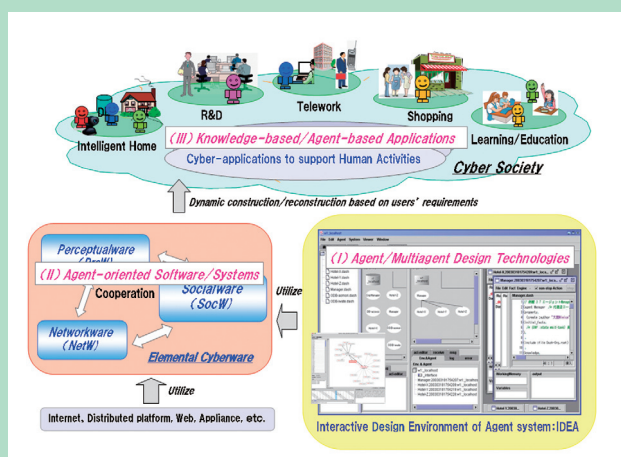

Knowledge-based System and its applications based on agent/multiagent technologies

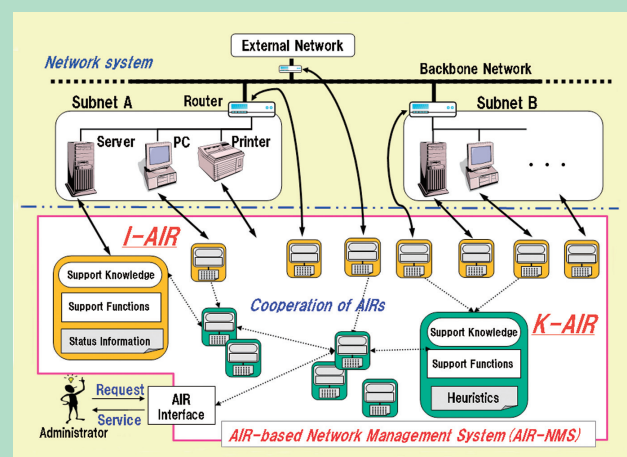

Network Management System based on Active Information Resources

Information Content

Staff:

Yoshifumi KITAMURA, Professor

Kazuki TAKASHIMA, Assistant Professor



Y. KITAMURA

K. TAKASHIMA

Research activities:

Good media content has the power to enrich our lives. Its effectiveness is becoming more and more important in a wide variety of fields, such as industry, education, culture, and entertainment. Expectations of its use in the general public are also increasing. Although the word content might be used to refer to a single image or music we use the broader definition of content.

Interactive Content Design (Prof. KITAMURA)

Content is provided to people through adequate output devices such as displays, such that people derive profound pleasure by interacting with it through an appropriate input device. Through these interactions with content on a computational device people can enhance their hedonistic feeling of satisfaction, happiness and excitement. Moreover, content is not always enjoyed alone but often in the company of others (e.g., friends, family, and so on) simultaneously. In these cases, it is necessary to consider the “environment” in which groups of people enjoy the content and “atmosphere” which is generated by the “environment.” Good interactive content has the potential to calm the “atmosphere” and in the process will often make the people in the environment more happy and friendly.

Thus, we focus on non-traditional content areas other than movies, music, and games, conducting comprehensive research on a variety of interactive content which creates new value through interactions with humans, by considering the atmosphere including the content and human. In this context, the focus of our group is in researching new and innovative techniques to interact with novel forms of content with the goal of enhancing the impact, effectiveness and hedonistic feelings of the content to improve and enrich people’s lives. We focus on non-traditional contents along side more traditional content like movies, music and games.

Research topics:

1. Displays and 3D Interaction Technologies

Designing original display systems to show visual information accurately and effectively, and interaction techniques to make better use of these display systems (Fig. 1).

2. Interactive Video Content

Creating new interactive content from real video taken by cameras and computer-generated animations (Fig. 2).

3. Modeling and Controlling the “Atmosphere” in a Conversation Space

Aiming to stimulate the “atmosphere” in a conversation space by supplying real-time feedback to the users, we are exploring means of sensing and analyzing changes in the space (Fig. 3).

4. Design and Evaluation of Novel Interaction Techniques

Designing and evaluating novel interaction techniques on target selection for variety types of displays including large and touch displays.

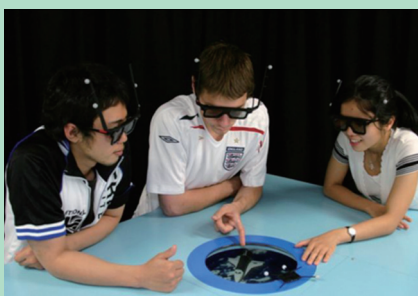

Fig. 1



Fig. 2

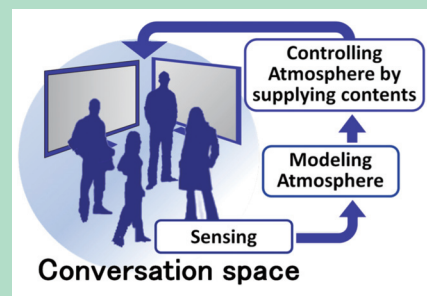

Fig. 3

Information Social Structure

Masafumi YANO, Visiting Professor



M. YANO

Research activities:

There are close relationship between the way of communication and the behavior of human beings The communication technology has so rapidly developed and brought about great social change including globalization of communication and physical distribution Even this sophisticated technology, however, does not still work in harmony with human nature Because the today information systems can only process learned information and requires all necessary information in advance It means that the present information system cannot adapt to changing environment In contrast, biological systems such as human beings can create information necessary to interpret external stimuli and to control actuators in real-time, by appropriately recognizing and judging unpredictably changing environment.

We will try to understand how living organisms create information, and to realize a new system for flexible information processing.

Information Social Structure

Norio SHIRATORI, Visiting Professor



N. SHIRATORI

Research activities:

In 21st century, we are facing with "global environmental changes" including global warming and "social structural changes" such as aging of the population. For absorbing and sublating these changes, we proposed a new computation paradigm, the concept of "Symbiotic Computing", in 1992. This idea places on values on harmony between "Agents" (e.g. human, computer, internet, robot, nature, country, culture and etc.). From the engineering point of view, we have been pursuing researches on the "Symbiotic Computing" which are its model, design and applications (Fig1).

Research topics:

1. Symbiotic Computing: Symbiotic between Human and Information System
2. Disaster-oriented Network · Green Computing
3. Net Media / Smart Home / Supervisory and Health Support System
4. Model of Symbiotic Information Society

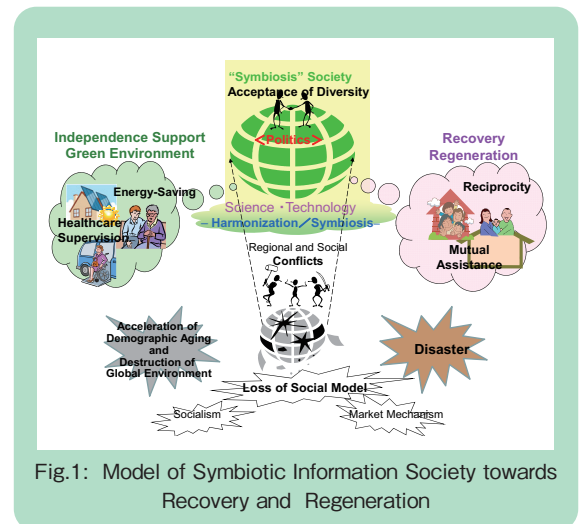

Fig.1: Model of Symbiotic Information Society towards Recovery and Regeneration

Sponsored Division

*Environmental-Adaptive Information
and Communication Engineering*



Environmental-Adaptive Information and Communication Engineering

Staff:

Eiki ADACHI, Professor



E. ADACHI

Research activities:

To embody a humanity-rich-communication by innovating information-and-communication technology (ICT) in the sustainable global society, we have to create human-friendly low-environmental-impact ICT devices and systems by using electronic materials and device-technology in the research fields of Nanotechnology, Spintronics and Information technology.

Our aim is that the embodiment of low-environmental-impact information devices and electronic equipments based on fundamental theory of spin and electron; these are designed by systematic survey of the rapidly-changing industry needs and R&D trends.

By analyzing the innovation trend in the fields of environmental and energy technologies, we embody innovative ICT devices and equipments. Further we would like to lead a related ICT researcher's community to the desirable trend.

Research topics:

1. Passive sensor technology development for recording of environmental variation as structural changes in nanomaterials
2. Fundamental research for ICT devices and equipments reducing environmental destruction by human activities
3. Survey research for industry needs and R&D trend induced by moving to an environmentally sound society



A smart city balanced between human society and natural environment



Atomically Controlled Processing

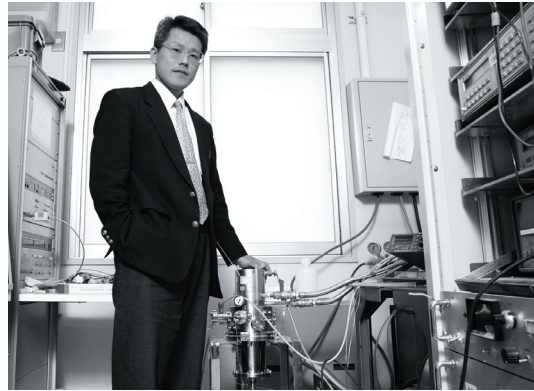

Laboratory for Nanoelectronics and Spintronics

Semiconductor Spintronics

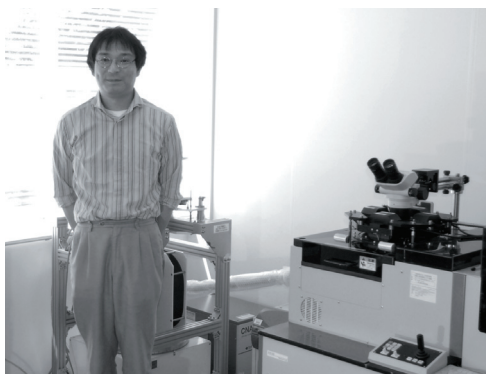
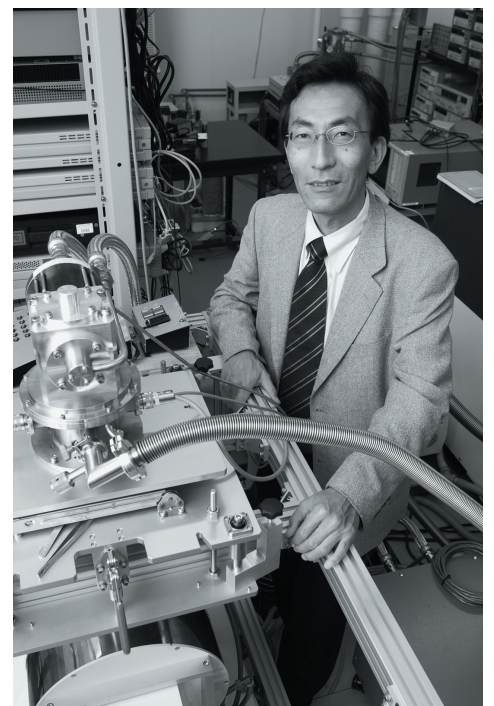
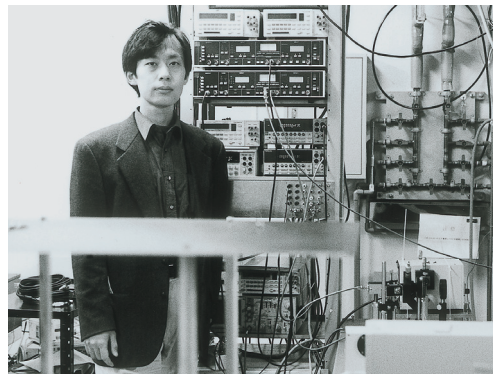

*Nano-Spin
Memory*



Nano-Molecular Devices



Laboratory for Nanoelectronics and Spintronics



R.SASAKI S.TSUCHIDA T.MEGURO J.MUROTA Y.NISHIMURA

Staff:

Director: Junichi MUROTA, Professor
Cooperation Section

Ryutaro SASAKI, Technical Official
Sadao TSUCHIDA, Technical Official
Toshiyasu MEGURO, Research Fellow
Youtaro NISHIMURA, Research Fellow

Research activities:

The Laboratory for Nanoelectronics and Spintronics of the Research Institute of Electrical Communication was established on April of 2004. Its purpose is to develop and establish the science and technology of nanoelectronics and spintronics for information technology. Utilizing the facilities installed in the Nanoelectronics-and-Spintronics building and under collaboration between the RIEC and electro-related laboratories of the Graduate Schools of Engineering, Information Sciences, Biomedical Engineering, Tohoku University, R&D of nanotechnologies of materials and devices in Nanoelectronics and Spintronics will be continued extensively. Furthermore, nation-wide and world-wide collaboration research projects will be conducted to build a systematic database in the electrical communication research area.

The Laboratory for Nanoelectronics and Spintronics mainly consists of research groups which promote following sections: Atomically Controlled Processing, Semiconductor Spintronics and Nano-Molecular Devices; together with the groups of Intelligent Nano-Integration System, Quantum-Optical Information Technology, and Ultra-Broadband Signal Processing. These groups cooperatively carry out the research aimed at establishing a world-wide COE in the research area of nanoelectronics and spintronics.

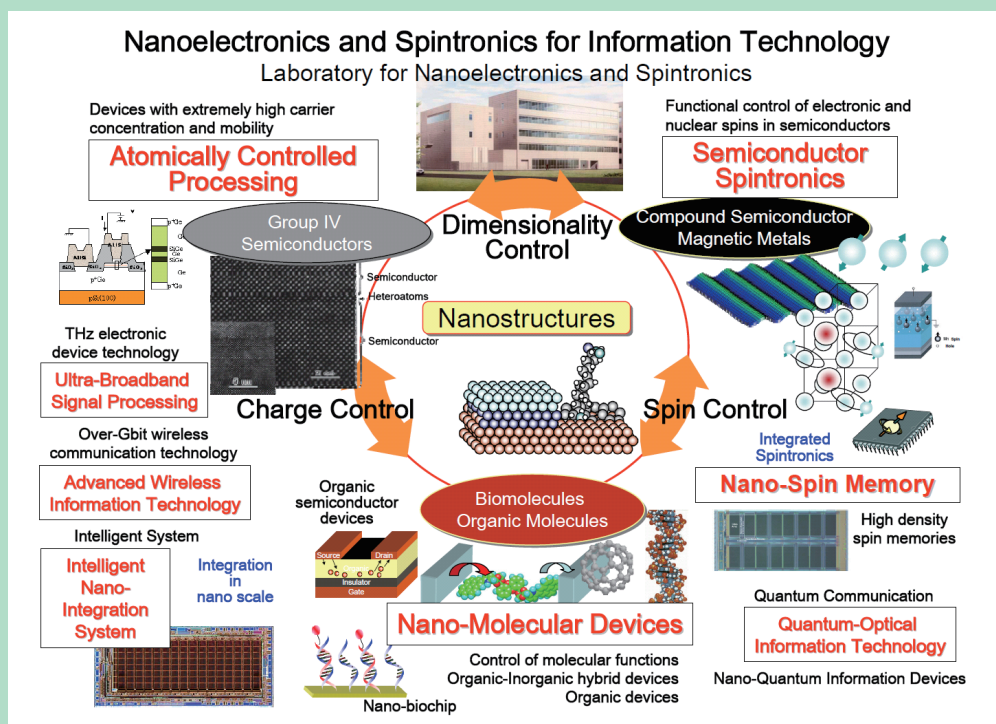

COE of International Research Collaboration

Based on the program(FY2005-2009) to build a system for international research collaboration by Special Funds for Education and Research (Ministry of Education, Culture, Sports, Science and Technology, Japan), we aim to establish COE in research fields of "Fabrication and application of semiconductor 3D-nanostructures", "Establishment and application of spin-control technologies in semiconductors", and "Realization and application of information processing using molecular nanostructures".



Academic Exchange Programs

IHP-Innovations for High Performance microelectronics, Germany
 Berlin Institute of Technology, Germany
 Interdisciplinary Center on Nanoscience of Marseille (CINaM)-CNRS/University of Mediterranean, France
 Institute of Semiconductors, Chinese Academy of Sciences, China
 Institute of Physics, Polish Academy of Sciences, Poland
 University of California, Santa Barbara (UCSB), USA
 Harvard University, USA
 University of Vigo, Spain

International Symposium held in LNS, RIEC

International Workshop on New Group IV Semiconductor Nanoelectronics (RIEC Symp.)

(1st: May 27-28, 2005; 2nd: October 2-3, 2006;
 3rd: November 8-9, 2007, 4th: September 25-27, 2008 ;
 5th: January 29-30, 2010)

RIEC Symposium on Spintronics

(1st: February 8-9, 2005; 2nd: February 15-16, 2006;
 3rd: October 31-November 1, 2007, 4th: October 9-10, 2008;
 5th: October 22-23, 2009; 6th: February 5-6, 2010;
 7th: February 2-3, 2011)

International Workshop on Nanostructure & Nanoelectronics

(1st: November 21-22, 2007; 2nd: March 11-12, 2010)

RIEC-CNSI Workshop on Nano & Nanoelectronics, Spintronics and Photonics

(1st: October 22-23, 2009)



3rd Int. Workshop on New Group IV Semiconductor Nanoelectronics



2nd RIEC Symposium on Spintronics-MgO-based Magnetic Tunnel Junction-Left: Albert Fert (received 2007 Nobel Prize in Physics); Right: Russel Cowburn

Atomically Controlled Processing

Staff:

Junichi MUROTA, Professor

Masao SAKURABA, Associate Professor

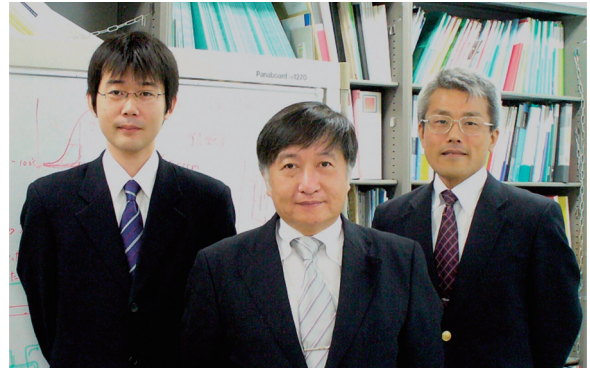

Y. CHIBA J. MUROTA M. SAKURABA

Research activities:

For highly functional semiconductor devices with ultrahigh speed and ultralow power for the Si LSIs, our atomically controlled processing technology by control of reaction in low-temperature CVD (Chemical Vapor Deposition) becomes important increasingly. Utilizing the technology, we aim to create non-equilibrium strain-controlled Si-Ge-C group IV semiconductors with high carrier concentration and high carrier mobility by advancing atomically controlled heteroepitaxial growth of Si, Ge, SiGe, SiGeC and impurity (B, P, C, N and so on) to the extremity. Moreover, we also aim to establish a technological basis for highly controlled nanometer-order three-dimensional structure formation.

By the above researches, highly strained nanometer-order three-dimensional structures and room temperature resonant tunneling structures with higher performance which exceeds the limit of physical properties in use of existing Si, SiGe alloy and Ge materials will be created. Simultaneously, by applying them to device fabrication, creation of group IV semiconductor quantum-effect nanodevice applicable to the large scale integration will be expected.

Atomically Controlled Processing (Prof. MUROTA)

The following researches are being advanced: (1) Control of extremely high carrier concentration due to non-equilibrium atomically controlled heteroepitaxial growth, (2) Modulation of energy band structure and carrier mobility due to introduction of atomically controlled strain into Si and Ge, (3) Formation of the nanometer-order three-dimensional structure with nanometer-order thickness utilizing CVD heteroepitaxial growth of unstrained Si/strained SiGe/Si heterostructures and selective etching with atomic layer control to form highly strained Si and SiGe layers and to achieve extremely high carrier mobility in Si-Ge materials.

Research topics:

1. Atomically controlled heteroepitaxial growth of Si-Ge-C group IV semiconductors
2. Atomic layer doping into nanometer-order heterostructures of group IV semiconductors
3. Three-dimensional nanometer-order fabrication of group IV semiconductor heterostructures
4. Fabrication process of Si-based highly strained nanometer-order heterostructure devices

Group IV Quantum Heterointegration (Assoc. Prof. SAKURABA)

The following researches are being advanced: (1) Atomic-order control of highly strained group IV semiconductor heterostructure formation in a nanometer-order ultrathin region which utilizing plasma CVD reaction at low temperatures without substrate heating, (2) Systematic investigation and control of charge transport phenomena including quantum phenomena in the highly strained group IV semiconductor heterostructures to find out novel electronic properties, (3) Heterointegration of the group IV semiconductor quantum heterostructures and high-performance nanodevices into the Si large-scale integrated circuits.

Research topics:

5. Low-damage plasma CVD process without substrate heating for epitaxial growth of highly strained group IV semiconductors
6. Large-scale integration process of group IV semiconductor quantum heterostructures
7. Fabrication of high-performance nanodevices utilizing group IV semiconductor quantum heterostructures

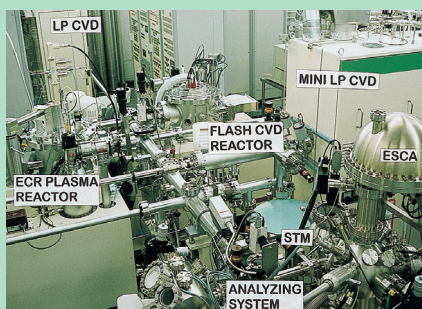

Atomically controlled processing systems for group IV semiconductors

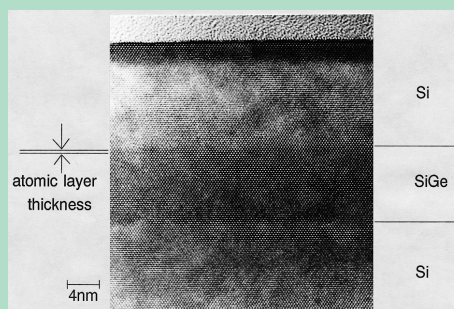

Atomic lattice image of a SiGe heterostructure grown by CVD at 500°C.

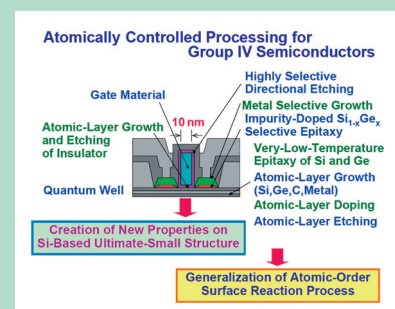

Atomically controlled processing for group IV semiconductors.

Semiconductor Spintronics

Staff:

Hideo OHNO, Professor
Yuzo OHNO, Associate Professor
Fumihiko MATSUKURA, Associate Professor
Shoji IKEDA, Associate Professor
Keita OHTANI, Assistant Professor
Mohsen GHALI, Research Fellow
Katsuya MIURA, Research Fellow

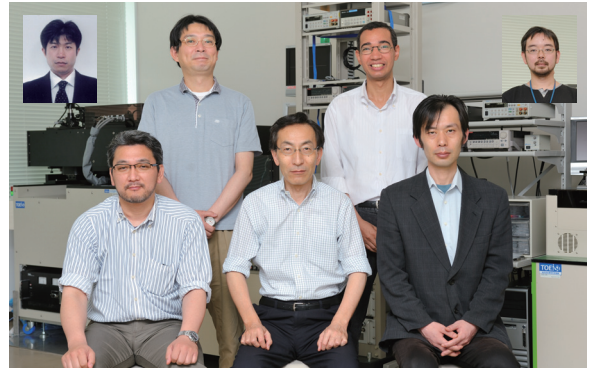

K. OHTANI F. MATSUKURA M. GHALI K. MIURA
S. IKEDA H. OHNO Y. OHNO

Research activities:

In order to realize new functional spintronic and high-speed devices, our research activities cover the areas of preparation, characterization, and application of new classes of solid state materials as well as their quantum structures, in which electronic and spin states can be controlled.

Functional Spintronics (Prof. H. OHNO)

We are working on materials, physics, devices and integration aspects of spintronics, in order to understand spin-related phenomena in condensed matter and to realize low-power functional spintronics devices.

Research topics:

1. Spintronics
2. Spin-related phenomena in semiconductors
3. Magnetic metal functional devices and their application
4. Quantum cascade structures and their application to THz optical devices

Functional Spin Photonics (Associate Prof. Y. OHNO)

We are studying the properties and coherent dynamics of electron and nuclear spins in semiconductor quantum structures by using such as high-sensitivity and high-time resolution optical characterization technique to establish novel spintronic devices technology.

Research topics:

5. Growth and characterization of electrical, optical, and spin properties of semiconductor quantum nanostructures
6. Spin coherence in semiconductor nanostructures and its application to quantum information technology and low power consumption technology

Functional Spintronics Materials (Associate Prof. MATSUKURA)

We are working on the fabrication and characterization of spintronics materials and their based structures, in order to demonstrate new principle of spintronics device operation.

Research topics:

7. Properties and application of magnetic semiconductors and their quantum structures

Nano-Spin Memory (Associate Prof. IKEDA)

We are developing technologies to realize high-performance low-power consumption spin memory and logic devices using magnetic tunnel junctions (MTJs) consisting of ferromagnetic metal electrodes with in-plane or perpendicular magnetic anisotropy and insulating barrier.

Research topics:

8. Magnetic tunnel junctions with high output voltage
9. Metal-based spintronics devices
10. Spin transfer torque memory and logic devices

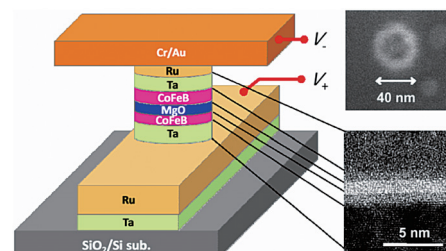
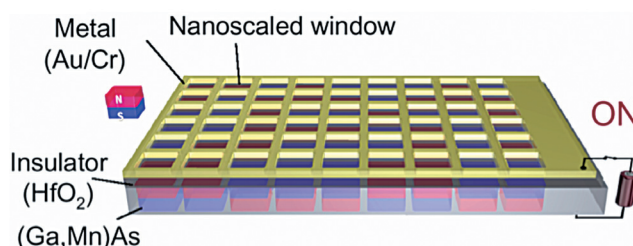

(Left) Schematic of electric-field defined magnetic nano-dots. (Right) Development of the world's first high performance 40 nm ϕ magnetic tunnel junctions (MTJs) with CoFeB/MgO perpendicular anisotropy.

Nano-Molecular Devices

Staff:

Michio NIWANO, Professor

Yasuo KIMURA, Associate Professor

Yuki AONUMA, Assistant Professor

Mohammad Maksudur RAHMAN, Research Fellow



Y. KIMURA
Y. AONUMA

M. M. Rahman
M. NIWANO

Research activities:

Miniaturization and performance improvement of various devices has been being sustained by the tremendous progress of the semiconductor fine processing technology. On the other hand, nanotechnology or biotechnology to prepare and manipulate biomolecules, supramolecules, and nanostructures with unique electric and optical properties that are hardly obtained from other materials are advancing. Our aim is the realization of molecule-sized electronic devices that can process various more sophisticated tasks by application of these unique materials based on the Si technology.

Nano-Molecular Devices (Prof. NIWANO)

Sensing systems for analysis of biological materials such as DNA and protein molecules at the Si semiconductor surfaces that manufactured and controlled by Si technology are developed. Observation equipments for biological materials and culture cells such as nerve cells are developed to elucidate the mechanism of intercellular communication and signal processing.

Research topics:

1. Development of bio-sensing systems at semiconductor surfaces (Surface-Biotronics)
2. Function analysis of dynamics of cells based on the semiconductor technology
3. Investigation of the signal processing of the nerve cell network

Nano-Electronic Device (Assoc. Prof. KIMURA)

The mechanism of formation processes of nanostructures is investigated. Based on the elucidated mechanism, the nanostructure formation process is controlled by the semiconductor fine processing technology. The novel processes will be able to generate functions of nanostructures simultaneously with control of the position of them to fabricate nano electronic devices.

Research topics:

4. Fabrication of nano electronic devices through electrochemical process
5. Fabrication of dye-sensitized solar cells using anodic TiO₂ nanotubes
6. Development of high-power organic electronic devices using supramolecules or organic molecules

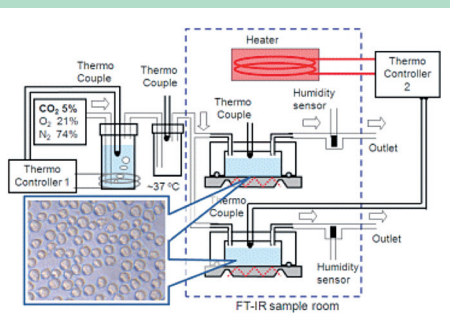

Fig.1: System for the analysis of biological functions of living cells using infrared spectroscopy.

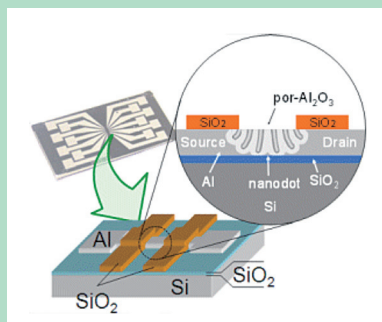

Fig.2: Single electron transistor (SET) fabricated by anodization.

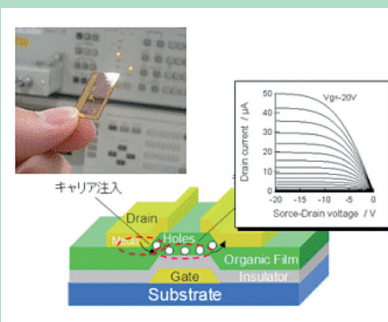
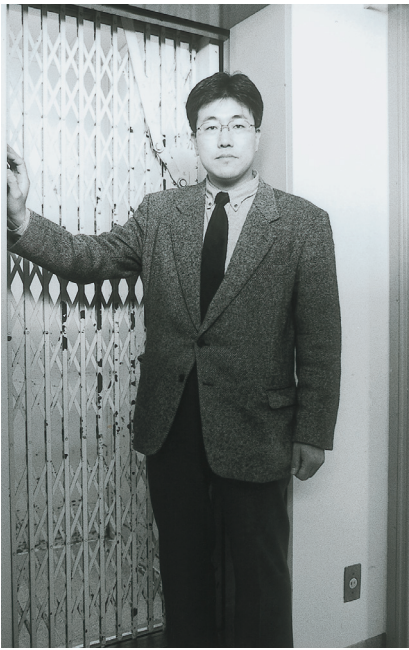

Fig.3: Organic field-effect transistor.



*New Paradigm
VLSI System*



Real-World Computing

Laboratory for Brainware Systems

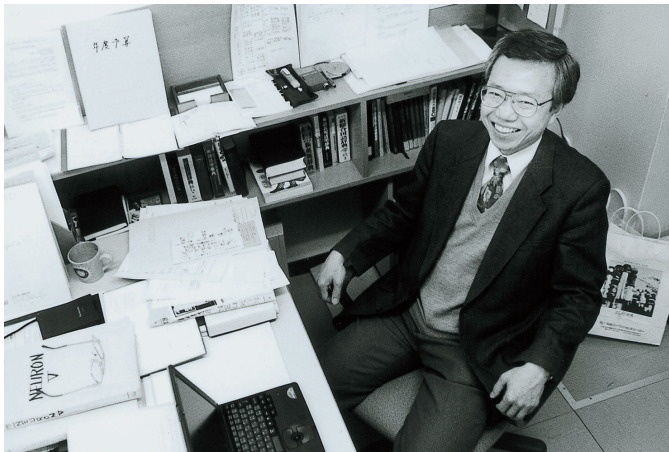

*Intelligent Nano-Integration
System*

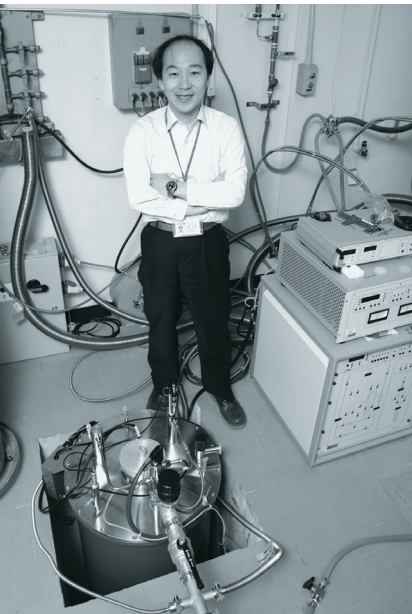

Microarchitecture



Laboratory for Brainware Systems



K. NAKAJIMA

Staff:

Director: Koji NAKAJIMA, Professor

The Laboratory for Brainware Systems of the Research Institute of Electrical Communication was established in 2004. Its purpose is to contribute to the research and development of advanced information science and technology for Brainware systems which realize a seamless fusion of the changeable and complex real world and the cyber space.

We aim at establishing scientific and technological foundations for Real-World Computing (section), New Paradigm VLSI System (section), Microarchitecture (section), Cyber Robotics (planning section), and Next-Generation Human Interface (planned section). The Laboratory for Brainware Systems consists of the above six sections which cooperatively carry out the research. At the same time they serve as a laboratory for nation-wide cooperative research in the field of Brainware systems.

The technology developed in the Laboratory is expected to enhance the research carried out in the four Divisions of the Institute, and the research conducted in the Divisions, in turn, is expected to provide scientific basis for the information technology developed in the Laboratory.

Physical and Adaptive Hardware Environment

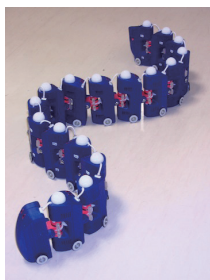

- Virtual Space Construction (Cyber Robotics)

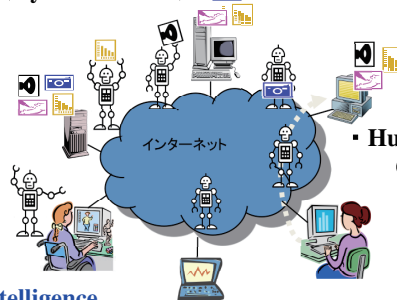

- Real-World Dynamical Intelligence (Real-World Computing)

Seamless Fusion of Real World and Multi-Modal Computing

- Human-Machine Cohabitation Architecture (Next-Generation Human Interface)
- Higher-Order Multimodal Perception and Information Generation (Multi-Modal Computing)

Hardware Environment with Massively Parallel Brain LSI



- Massively Parallel Neural LSI (Intelligent Nano-Integration System)

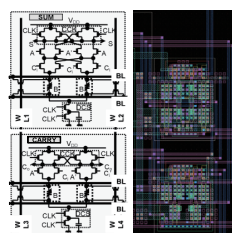

- Nonvolatile Logic and Its Applications (New Paradigm VLSI System)

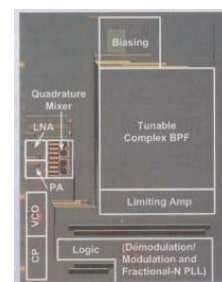

- Mixed Signal SoC Design (Microarchitecture)

Real-World Computing

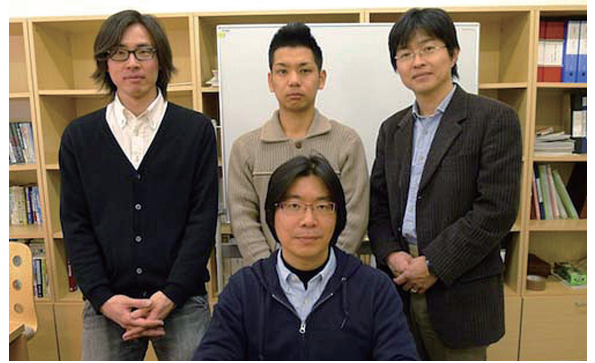

D. OWAKI T. KANO K. SAKAMOTO
A. ISHIGURO

Staff:

Akio ISHIGURO, Professor

Dai OWAKI, Assistant Professor

Takeshi KANO, Assistant Professor

Kazuhiro SAKAMOTO, Assistant Professor

Wataru WATANABE, Research Fellow

Takahide SATO, Research Fellow

Real-World Computing (Prof. ISHIGURO)

Living organisms exhibit surprisingly adaptive and versatile behaviors in real time under unpredictable and unstructured real world constraints. Such behaviors are achieved via spatiotemporal coordination of a significantly large number of bodily degrees of freedom. Clarifying these remarkable abilities enable us to understand life-like complex adaptive systems as well as to construct truly intelligent artificial systems. A prominent concept for addressing this issue is “autonomous decentralized control”, in which non-trivial macroscopic functionalities are emerged via spatiotemporal coordination among vast amount of autonomous components that cannot be explained solely in terms of individual functionality.

We study the design principles of autonomous decentralized systems that exhibit life-like resilient behaviors from the viewpoints of robotics, biology, mathematics, nonlinear science, and physics.

Research topics:

1. Control of soft-bodied robots with large degrees of bodily freedom
2. Autonomous decentralized control for various types of locomotion, e.g., slithering, swimming, flying, walking, running.
3. Dynamical system approach to understand versatility and its application to robotics.

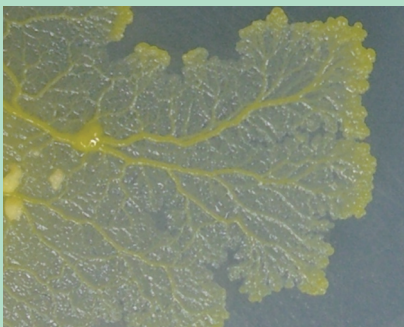

True slime mold as a good living organism for studying autonomous decentralized control

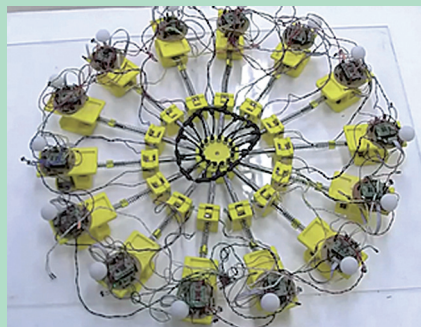

Soft-bodied amoeboid robot driven by a fully decentralized control scheme extracted from true slime mold.

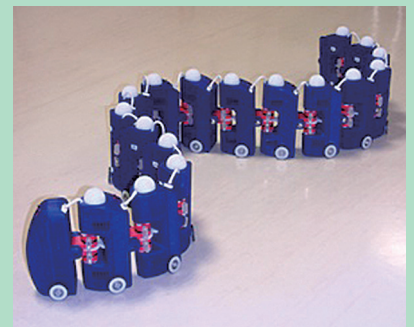

Autonomous decentralized control of a snake-like robot that exhibits highly adaptive and resilient properties.

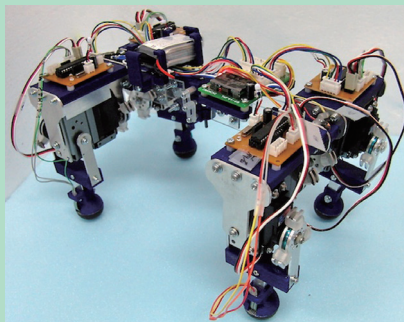

Quadruped robot driven by a fully decentralized control

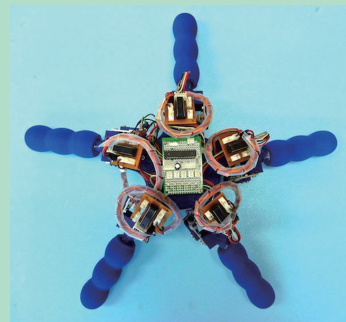

Ophiroid robot that enables omnidirectional locomotion

Intelligent Nano-Integration System

Staff:

Koji NAKAJIMA, Professor

Shigeo SATO, Associate Professor

Takeshi ONOMI, Assistant Professor



T. ONOMI K. NAKAJIMA S. SATO

Research activities:

Our research activities cover the fields of architectures of Brain computing systems, characterization and application of artificial neural networks, and fabrications of intelligent integrated circuits, and exploitation of new devices for neural circuits.

Intelligent Nano-Integration System (Prof. NAKAJIMA)

We have constructed a stochastic artificial neural network with one million synaptic units, analyzed the dynamic behaviour of neural networks aiming at a time-dependent data processing, succeeded to propose a system where we are able to get off successfully from any local minima fallen into on the way of data processing in neural networks, and fabricated its prototype hardware system on the silicon microchip for brain computing systems. We have also presented an FFT and a neural system operated by using a flux quantum logic in superconducting integrated circuits.

Research topics:

1. Basic architecture for integrated active Brain computers
2. Dynamic intelligent associative memory system
3. Superconducting single flux-quantum data-processor

Integrated Superconducting Quantum System (Assoc. Prof. SATO)

We study on implementation of high-T_c superconductor multi qubits using intrinsic Josephson junctions and neuromorphic adiabatic quantum computation algorithms for practical solid-state quantum computer and its application to brain computing systems.

Research topics:

4. High-T_c Superconductor Qubit
5. Adiabatic Quantum Computation Algorithm

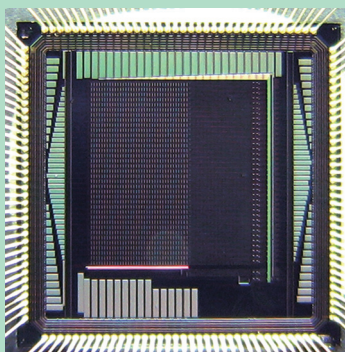

Microchip of a neural network

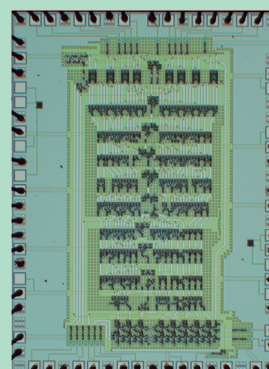

Microchip of a single flux-quantum circuit

Microarchitecture

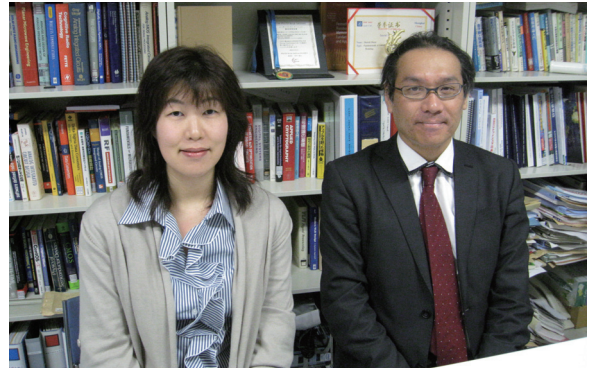

T. KAHO

S. MASUI

Staff:

Shoichi MASUI, Professor

Takana KAHO, Visiting Associate Professor

Research activities:

Ubiquitous society has been established by the deployment of various wireless systems ICs, and it demands advances in mixed-signal (analog and digital) design technique and higher integration through SoCs (System on a Chips). Our research activities include architecture and circuit design of mixed-signal SoC applicable to wireless sensor network systems for the healthcare applications and investigations on brain activities. Since a mixed-signal SoC combines RF/analog and digital blocks to minimize cost and power consumption, scaled CMOS technologies must be used to minimize the digital block area. However, this scaling results in the significant degradation of the intrinsic gain in analog transistors and the increase of power consumption if the dynamic range is maintained with the reduced supply voltage. To overcome these problems, innovative improvements in the design of SoC architectures and circuits as well as their design methodology are required.

Our approaches expand digitally-assisted analog circuit design techniques to realize a mixed-signal platform for the minimization of power/energy consumption in scaled CMOS technology. Furthermore, we focus on the innovations in the RF/analog design methodology to minimize the development cost of the mixed-signal SoCs.

Microarchitecture (Prof. Masui)

In the mixed-signal platform, the compensation techniques for the gain reduction and tuning techniques for process variations in analog components are adopted with the basis of the digitally-assisted analog design. Moreover, the state-of-the-art RF/analog design methodology can minimize the power/energy consumption in the mixed-signal platform. We have developed a prototype low-power transceiver for wireless sensor network systems with low-IF architecture featuring a complex bandpass filter (BPF) with automatic digital tuning circuit. We are also targeting the minimization of the power consumption in BPF with a newly developed active- G_m -RC architecture.

In terms of the design methodology, we have been investigating the analog design optimization with g_m/I_D lookup tables. So far, we have established the power minimum design for the 2-stage Miller-compensated OTA (operational transconductance amplifier) and gain-boosted folded-cascode OTA; and in the latter application, we observed 40% power reduction compared with a conventional design result. We are applying this technique to the verification of transistor model parameters in various technologies.

The planned research project will take advantage of collaborations with semiconductor industries and EDA (Electronic Design Automation) vendors and relationships with overseas universities and startup companies.

Research topics:

1. Mixed-signal SoC architecture and circuit design for wireless sensor network systems
2. Design automation and associated topdown design methodologies for RF/analog circuits.
3. Design and applications of software-definable mixed-signal circuits
4. Design and applications of nonvolatile memory

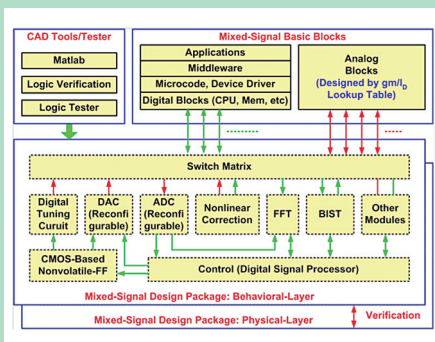

Mixed-signal Platform

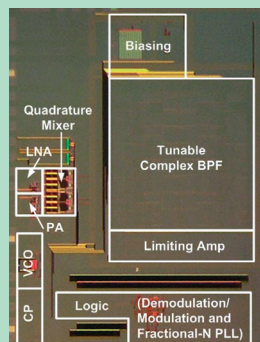

Transceiver IC for Sensor Network Systems

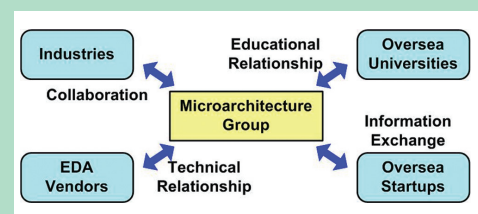

Vision of Collaboration

New Paradigm VLSI System

Staff:

Takahiro HANYU, Professor

Masanori NATSUI, Assistant Professor

Atsushi MATSUMOTO, Assistant Professor



T. HANYU

A. MATSUMOTO M. NATSUI

Research activities:

Very Large-Scaled Integrated (VLSI) processors and their applications to electronic systems, where VLSI processors are used as a "brain" for intelligent control like human beings, are the key components in the recent information-communication-technology (ICT) society, while the demands for improving power-efficiency and system-reliability with maintaining their higher performances are still getting increased in the recent nano-scaled era. In this research division, we design and implement a low-power and highly reliable VLSI processor using novel device technologies and new-paradigm circuit architecture such as logic-in-memory architecture.

New Paradigm VLSI System (Prof. Hanyu)

Rapid progress in recent deep submicron regime has led to the capability to realize giga-scaled embedded systems on a chip, while the communication bottleneck between memory and logic modules has increasingly become a serious problem. In addition, power dissipation and device-characteristic variation have been also the emerging problems in the recent VLSI chip. In order to solve such the recent VLSI problems causing performance and reliability degradation, we focus on a "new-paradigm VLSI computing" concept that investigates the optimal design through all the VLSI design layers such as a device/material design level, a circuit-architecture level, a logic-synthesis level, a system-architecture level, and an application-oriented algorithm level. The use of "logic-in-memory VLSI architecture," where storage elements are distributed over a logic-circuit plane, makes global wires reduced greatly. To implement a logic-in-memory VLSI compactly, we utilize multi-functional and nonvolatile devices such as ferroelectric devices, magnetic tunnel junction (MTJ) devices and phase-change devices. We are also focusing on other challenging research subjects concerning with a new-paradigm VLSI computing system, such as asynchronous network-on-chip (NoC) and process-voltage-temperature (PVT) variation-aware VLSI architecture. Preliminary research subjects in our laboratory are listed below:

Research topics:

1. Logic-in-memory VLSI architecture and its applications
2. Nonvolatile logic and its application to ultra-low-power VLSI processors
3. PVT-variation-aware VLSI architecture and its applications
4. Device-model-based new-paradigm VLSI computing architecture
5. Asynchronous-control/multiple-valued data representation-based circuit for a high-performance Network-on-Chip



Research Center for 21st Century Information Technology

*Technology Development
Division
Mobile Wireless Technology
Group*



*Technology Development
Division
Storage Technology Group*

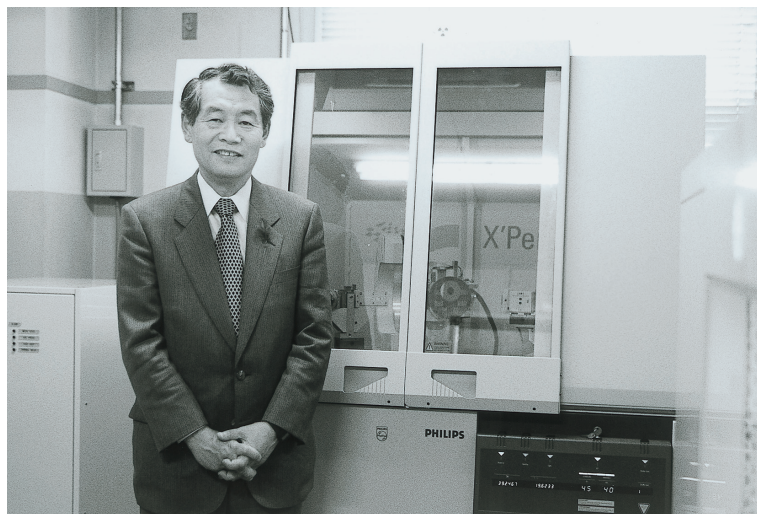
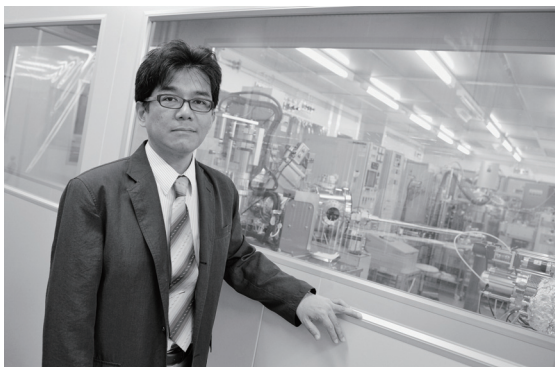

Research Center for 21st Century Information Technology (IT-21Center)

Director: Hiroaki MURAOKA, Professor

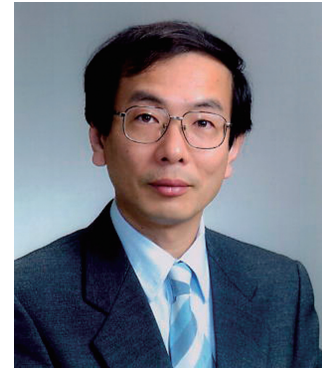

H. MURAOKA

Project Planning Division

Makoto FURUNISHI, Visiting Professor

Technology Development Division

Development of Dependable Wireless System and Device

Project Leader : Kazuo TSUBOUCHI, Visiting Professor

Tadashi TAKAGI, Visiting Professor

Development of Super High-Speed Mass Storage HDD Systems

Project Leader : Hiroaki MURAOKA, Professor *

Kazuhisa FUJIMOTO, Professor

Hajime AOI, Visiting Professor

Takehito SHIMATSU, Associate Professor

Kiyoshi YAMAKAWA, Visiting Associate Professor



IT-21 Center

The purpose of the IT-21 center is development of practical technologies for IT based on the advanced technologies of RIEC with the partnership among Industry, Government and Universities. The term of development is limited less than 5 years. The projects are planed on matching with both basic technologies in the University and application in the Industry. Combination of the technologies of the University and Industry makes practical technologies with availability for the commercial products. The center actively accelerates to obtain the intellectual properties generated from the development of practical technology to the Industry.

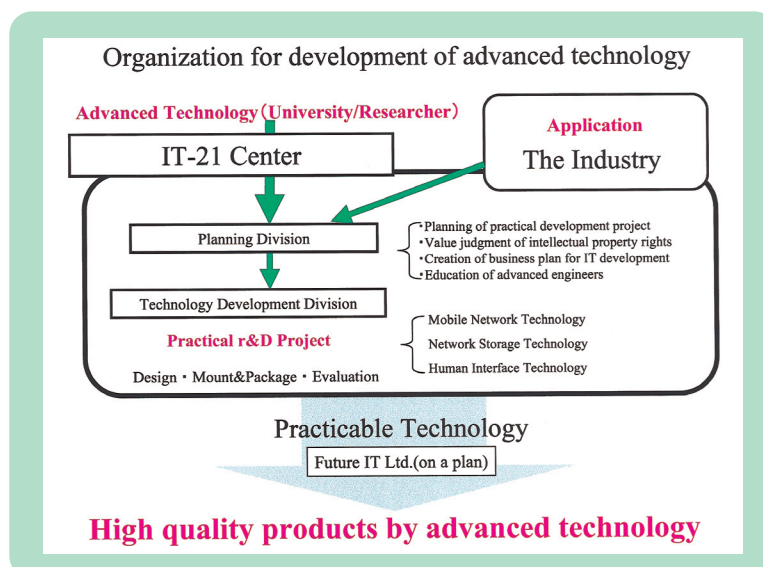

Technology Development Division

Storage Technology Group

Staff:

Kazuhisa FUJIMOTO, Professor

Hajime AOI, Visiting Professor

Takehito SHIMATSU, Associate Professor

Kiyoshi YAMAKAWA, Visiting Associate Professor

Susumu OGAWA, Research Fellow

Hideki SAGA, Research Fellow

Masaki YAMADA, Research Fellow



K. YAMAKAWA M. YAMADA H. AKAIKE D. INOUE H. KATAOKA H. SAGA Y. OSAWA
S. OGAWA T. SHIMATSU K. FUJIMOTO H. AOI

Hirotohi AKAIKE, Research Fellow

Yuichi OSAWA, Research Fellow

Hiroyasu KATAOKA, Research Fellow

Daisuke INOUE, Research Fellow

Research activities:

High density and high data-rate hard disk drive (HDD) information storage technologies are core technologies for IT infrastructure. In Japanese universities, only the Research Institute of Electrical Communication (RIEC) has maintained a comprehensive progress of research into information storage technology, including materials, devices and theory.

In March 2007, the IT21 cooperative research project between industry, academia and government was successfully finished. An ultra-high small perpendicular magnetic recording prototype HDD and basic technologies for densities of 0.5 to 1 Tbits/inch² were developed during the project.

A new project ;Development of super high-speed mass storage HDD systems started in August 2007 under the collaborations between RIEC including IT21 storage technology group, major Japanese HDD manufacturers and other laboratories researching related technologies within Tohoku University.

The goals of this project are to develop the perpendicular recording technologies required for higher than 2 Tbits/inch² recording density and, based on these technologies, to develop the system architecture for realizing large capacity, high performance and low power consumption storage systems.

Research topics:

1. Development of fundamental technologies for the recording densities over 2 Tb/inch²; high sensitivity sensors, high recording resolution SPT writers and high-density media including patterned media.
2. Development of a system architecture for high performance and low power consumption storage systems.

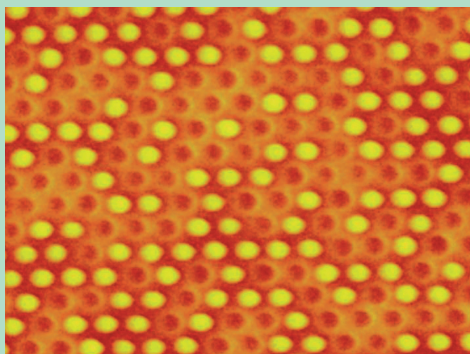

MFM images of a L1,-CoPt patterned films (One of fundamental technologies to realize densities of over 2 Tbits/in².)

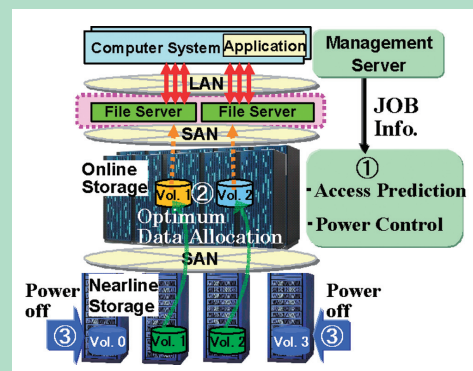

2-dimension data allocation method with an access prediction



Fundamental Technology Center

Flexible Information System Research Center Fundamental Technology Center Management Office for Safety and Health



*Flexible Information
System
Research Center*

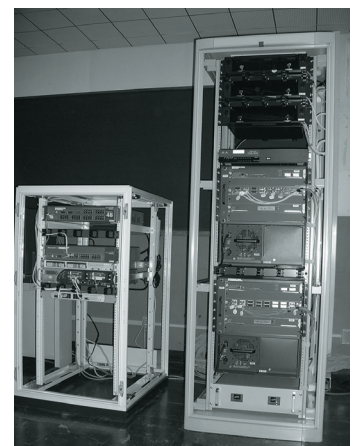

Flexible Information System Research Center

Staff:

Director: Yôiti SUZUKI, Professor
Yoshihito TOYAMA, Professor*
Takuo SUGANUMA, Professor*
Gen KITAGATA, Associate Professor
Kazuto SASAI, Assistant Professor
Masahiko SATO, Technical Official
Johan SVEHOLM, Research Fellow

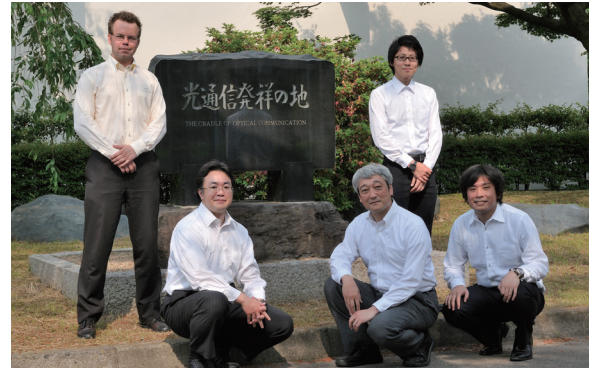

J. SVEHOLM M. SATO
 G. KITAGATA Y. SUZUKI K. SASAI

Research activities:

The present information systems represented by computers are inflexible systems, because their uses are predefined and they provide only the fixed processing and functions. The flexible information system on the other hand, is a system which can perform the flexible information processing adopted to the human intention and situation of its environment, and this can correspond to the flexible human thinking using multi-dimension perceptual information such as the visual and auditory senses fully, beyond the limitations of the principles of the inflexible information processing. The aims of this research are the exploration of principles of the flexible information processing through the theories and experiments, and the establishment of their system construction methodology.

Moreover, we also study the flexible distributed systems for advanced organization, utilization, administration, operation and dispatching of science information, and are aiming at the establishment of construction methodology of them confirming the effectiveness of the system with practical applications to the scientific information of RIEC on the network.

Research topics:

1. Information collection, organization, dispatching, utilization and research support environment.
2. Advanced maintenance, management and operation of network.
3. Relation between technology and ethics.
4. Perceptual information processing of living bodies and intelligent UI and OA.



Network room

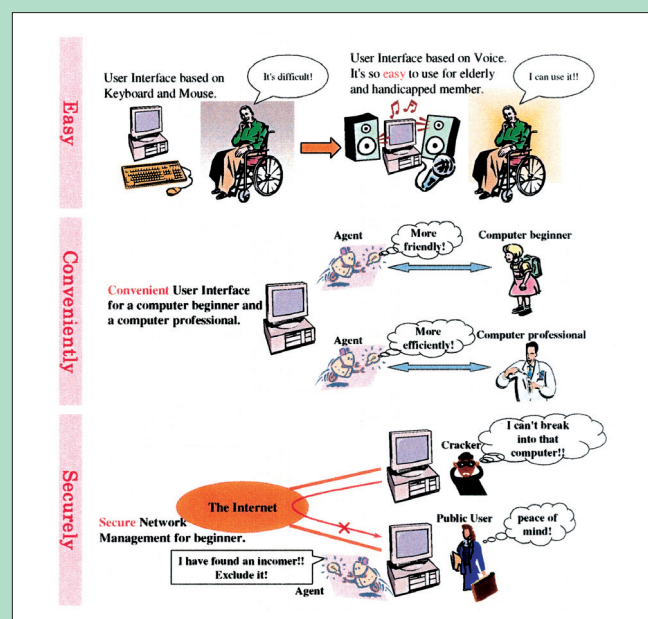

Flexible Global Network

Fundamental Technology Center

Staff:

Director: Yoichi UEHARA, Professor

Nobuyuki SATO, Assistant Professor

Fumitaka SAITO, Technical Official

Katsumi SAGAE, Technical Official

Koichi SHOJI, Technical Official

Tamotsu SUENAGA, Technical Official

Keisuke SATO, Technical Official

Hiroshi WATANABE, Technical Official

Yuji KONNO, Technical Official

Choichi TAKYU, Technical Official



N. SATO H. WATANABE T. SUENAGA Y. KONNO
K. ABE K. SAGAE K. SATO R. YONEZAWA M. ABE C. TAKYU
S. AGATSUMA K. SHOJI F. SAITO Y. UEHARA M. SUGAWARA

Maho ABE, Technical Official

Kento ABE, Technical Official

Munetomo SUGAWARA, Technical Official

Ryuji YONEZAWA, Technical Official

Shigeto AGATSUMA, Technical Official

Pioneering researches and developments (R&D) in the wide range of disciplines spreading from basic sciences to applied communication technologies have been carried out in the institute. Technical officials have traditionally contributed these through their well established skills and experienced knowledge. In order to maintain and develop such contributions towards the future, the institute established the fundamental technology center in 2007. The technical supports required commonly in the institute were rearranged in four technical divisions, i.e., machine, evaluation, processing, and software technical divisions. These divisions take charge of the following services.

The machine shop division develops advanced machining techniques, and offers them for developing and manufacturing experimental apparatuses (e.g., see Fig. 1). This division also provides machining instructions to the students and faculty members who carry out machining by themselves. The evaluation division offers various evaluation and measurement techniques such as focused ion beam system (see Fig. 2) and electron probe X-ray micro analyzer (see Fig. 3). The glass machining and the supply of liquid helium and nitrogen are also covered by this division. The processing division is, in cooperation with the evaluation division, responsible for operating and maintaining the project clean room (PCR), one of the common-use clean rooms in the institute. Nanometer-scale electron beam lithographic techniques and customized optical filters in the visible and infrared spectral range can be provided by this division. The software technology division operates and maintains the computer networks in the institute.

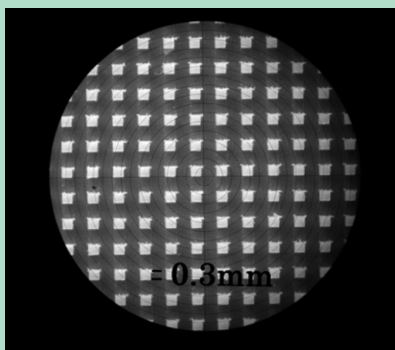

Figure 1 Dot patterned stamp



Figure 2 Focused ion beam system (FIB)



Figure 3 Electron Probe X-ray Micro Analyzer (EPMA)

Management Office for Safety and Health

Staff:

Manager: Michio NIWANO, Professor

Deputy Manager: Yoichi UEHARA, Professor

Nobuyuki SATO, Assistant Professor

The Management Office for Safety and Health is an organization with the objective of maintaining the health and safety of staff and students working at the institute. The use of chemicals, high-pressure gas and radiation in research activities at the institute entails many risks. The Management Office for Safety and Health provides support for safety and health management in facilities such as research laboratories, experimental facilities, and machine shops through various activities to ensure that research activities within the institute are conducted safely and smoothly.

With respect to safety and health management, the Safety and Health Committee, comprising the Director, staff at the institute and industrial physicians, discusses various matters related to safety and health and the maintenance of the safety and health management system at the institute, and submits recommendations to the Director and Faculty Council. The Director and Faculty Council then finalize guidelines as advised by the contents of these recommendations. The guidelines are then implemented into actual safety and health management operations at each of the facilities such as research laboratories.

Under collaboration with these organizations, the Management Office for Safety and Health takes charge of practices related to safety and health, and operates to ensure safety and convenience in research activities at the institute.

Activity contents:

1. Inspection of and assistance in improving the safety and health management system and working environment within the institute.
2. Investigation of laws related to safety and health and collection of information regarding safety and health management.
3. Provision of advice and information to safety and health personnel in each department.
4. Implementation of various types of safety education targeted at staff and students.
5. Liaison and coordination with the supervisory authority and other departments on campus.



Safety and health seminar



High-pressure gas seminar

Research Activities

Study Groups on Electrical Communication

Study Groups on Electrical Communication are organized to solve scientific and technological problems and to promote research and development through the collaboration of the Research Institute of Electrical Communication, Group of ECEI (Electrical Engineering, Communication Engineering, Electronic Engineering, and Information Engineering) in Graduate Schools of Engineering, Information Sciences, Biomedical Engineering, related scientists and engineers inside and outside Tohoku University. The Study Groups on Electrical Communication consist of 15 Sub-Groups as listed, to deal with specific subjects. Each Sub-Group holds workshops and the abstracts of the workshops are published annually in *The Record of Electrical and Communication Engineering Conversation Tohoku University*.

Many scientists and engineers not only from universities but also from government laboratories and industries attend the workshops, present papers, and discuss issues very actively. We are pleased to provide information on these activities upon request. Please contact the General Chairman or each Sub-Group Chairman for general information or more specific questions.

Title of Sub-Group

Electromagnetic and Optical Waves Engineering	New Paradigm Computing
Acoustic Engineering	Ultrasonic Electronics
Sendai "Plasma Forum"	Brainware
Sendai Seminar on EMC	Mathematical Physics and its Application to Information Sciences
Computer Science	
Systems Control	Biocybernetics and Bioinformatics
Information-biotronics	Nanoelectronics and Spintronics
Spinics	Advanced Information Communication Engineering



The 7th International Symposium

Symposiums Organized by the Institute

This Symposium is planned to exchange relevant information on current important topics concerning Electrical Eng., Electrical Communications, Electronic Eng., and Information Eng. Many related researchers inside and outside Tohoku University participate the Symposium and stimulate discussion.

Past Symposium

	Title	Date
1	Quantum Electronics of Light Waves and Micro Waves	Feb. 6- 8, 1964
	Magnetic Recording	Feb.14-15, 1964
2	Ultra-High Frequency Acoustoelectronics	Feb.11-12, 1965
3	Artificial Intelligence	Mar. 8- 9, 1966
4	Thin Film Electronics	Jan.26-27, 1967
5	Crystal Growth	Dec.19-20, 1967
6	1968 Sendai Symposium on Acoustoelectronics	Aug.19-20, 1968
7	Current Status and Future Trends of Superconductivity	Jan.22-24, 1970
8	Speech Information Processing	Feb.24-26, 1971
9	Surface Acoustic Wave Technology	May.25-26, 1972
10	Liquid Crystals • Their Molecular Orientations and Application to Display Devices	Dec.13-14, 1974
11	Computer Network	Mar.17-18, 1975
12	The Memorial Symposium on the 40th Anniversary of the Foundation of RIEC	Sep.25-26, 1975
13	Application of Amorphous Ferromagnetic Materials	Mar.10-11, 1977
14	Stoichiometry of Compound Crystals	Nov.24-25, 1977
15	Submillimeter Waves	Nov.16-17, 1978
16	Solid State Chemical Sensors	Feb. 1- 2, 1980
17	Graph Theory and Algorithms	Oct.24-25, 1980
18	Perpendicular Magnetic Recording	Mar.11-12, 1982
19	Approach to Optical Computer	Mar.10-11, 1983
20	Plasma Non-Linear Phenomena - Basic Problems for Fusion Plasmas	Mar. 8- 9, 1984
21	New Computer Architecture	Jul.25-26, 1985
22	Guided Wave Technology and Its Application at Mid-Infrared	Mar.13-14, 1986
23	Physics and Applications of Tunnelling Phenomena	Mar.12-14, 1987
24	Biomagnetics and Bioelectronics	Feb.26-27, 1988
25	Ultrasonic Electronics - New Applications of Piezoelectricity	Feb. 2- 3, 1989
26	Boundaries between Light and Electromagnetic Wave	Feb. 1- 2, 1990
27	Issues and Realization of Pattern Recognition and Understanding	Feb.28-Mar.1, 1991
28	Discrete Algorithms	Oct.17-18, 1991
29	Perspective for New Computing Paradigm	Feb. 4- 5, 1993
	Current Status and Future Prospects of System Control	Mar. 3- 4, 1993
30	Future Prospects of Electron Beam Devices	Nov. 1- 2, 1993
31	Discharge and EMC	Dec.20-21, 1994
32	Statistical Physics and Information Science	Mar.22-23, 1995
33	Photo-and Plasma-Excited Processes on Surfaces	Nov.30-Dec.1, 1995
34	Nano Spinics and Power Electronics	Feb.15-16, 1996
35	Potential Formation and Related Nonlinear Phenomena in Plasmas	Sep.17-19, 1996
36	New Trend in Ultrasonic Measurements	Feb. 3- 4, 1997
37	Toward the Realization of the High-Definition Multi-Media Communication	Nov. 4- 6, 1997

International Symposium organized by the Institute

	Title	Date
1	Intrinsic Josephson Effect and THz Plasma Oscillation in High T _c Superconductors	Feb.23-25, 1997
2	Design and Architecture of Information Processing Systems Based on The Brain Information Principle	Mar.16-18, 1998
3	Novel Techniques and Applications of Millimeter-Waves	Dec.14-16, 1998
4	The International Joint Conference on Silicon Epitaxy and Heterostructures	Sep.13-17, 1999
5	International Workshop on Photonic and Electromagnetic Crystal Structures	Mar.8-10, 2000
6	Physics and Application Spin Related Phenomena in Semiconductors	Sep.13-15, 2000
7	Rewriting in Proof and Computation	Oct.25-27, 2001
8	Nonlinear Theory and its Applications	Oct.28-Nov.1, 2001
9	New Paradigm VLSI Computing	Dec.12-14, 2002
10	Ultra High Density Spinic Storage System	Oct.23-24, 2003
11	3rd International Workshop on New Group IV (Si-Ge-C) Semiconductors	Oct.12-13, 2004
12	3rd International Workshop on High Frequency Micromagnetic Devices and Materials (MMDM3)	Apr.11-12, 2005
13	4th International Conference on Silicon Epitaxy and Heterostructures (ICSI-4)	May.23-26, 2005
14	1st International WorkShop on New Group IV Semiconductor Nanoelectronics	May.27-28, 2005
15	GSIS International Symposium on Information Sciences of New Era: Brain, Mind and Society	Sep.26-27, 2005
16	The 1st RIEC International Workshop on Spintronics -Spin Transfer Phenomena-	Feb.8-9, 2006
17	4th International Workshopn on High Frequency Micromagnetic Devices and Materials (MMDM4)	May 8,2006
18	4th International Conference on Physics and Applications of Spin-Related Phenomena in Semiconductors (PASPS-IV)	Aug.15-18,2006
19	2nd International Workshop on New Group IV Semiconductor Nanoelectronics	Oct.2-3,2006
20	2nd RIEC International Workshop on Spintronics	Feb.15-16,2007
21	Japan-China Joint Conference on acoustics, JCA2007	Jun.4-6,2007
22	International Conference on Discovery Science / International Conference on Algorithmic Learning Theory	Oct.1-4,2007
23	The 3rd RIEC International Workshop on Spintronics	Oct. 31-Nov.1,2007
24	3rd International Workshop on New Group IV Semiconductor Nanoelectronics	Nov.8-9,2007
25	International Workshop on Nanostructures & Nanoelectronics	Nov.21-22,2007
26	The 18th International Symposium on Algorithms and Computation (ISAAC2007)	Dec.17-19,2007
27	International Interdisciplinary-Symposium on Gaseous and Liquid Plasmas (ISGLP 2008)	Sep.5-6,2008
28	4th International Workshop on New Group IV Semiconductor Nanoelectronics	Sep.25-27,2008
29	The 4th RIEC International Workshop on Spintronics	Oct.9-10,2008
30	GSMM 2009 (Global Symposium on Millimeter Waves 2009)	Apr.20-22,2009
31	Mini R.I.E.C. workshop on multimodal perception	Apr.24-25,2009
32	The 4th International Symposium on Ultrafast Photonic Technologies	Aug.4-5,2009
33	PIMRC2009 (Personal Indoor and Mobile Radio Communications Symposium 2009)	Sep.13-16,2009
34	2nd RIEC-CNSI Workshop on Nanoelectronics,Spintronics and Photonics (5th RIEC Symposium on Spintronics)	Oct.22-23,2009
35	International workshop on the principles and applications of spatial hearing 2009 (IWPASH2009)	Nov.11-13,2009
36	5th International Workshop on New Group IV Semiconductor Nanoelectronics	Jan.29-30,2010
37	6th RIEC International workshop on Spintronics	Feb.5-6,2010
38	2nd International Workshop on Nanostructure & Nanoelectronics	Mar.11-12,2010
39	2nd RIEC International Symposium on Graphene Devices (ISGD2010)	Oct.27-29,2010
40	9th Japan-Korea Symposium on Surface Nanostructures (JKSSN9)	Nov.15-16,2010
41	The 7th RIEC International Workshop on Spintronics	Feb.3-4,2011

Periodicals Published by the Institute

The Institute publishes the following two periodicals to inform readers on recent research results of the Institute.

1. The Record of Electrical and Communication Engineering Conversatione Tohoku University

This journal aims at providing an opportunity to publish research results of the Institute as well as the result of the Graduate Schools of Engineering, Information Sciences, Biomedical Engineering. Since the journal also aims at publishing general research activities of the Institute and of the Graduate Schools such as records of the final lectures of retiring professors, records of the Institute Symposium, and reviews.

The name of the Journal 'Conversatione' is attributable to the 'Tuesday Conversatione' at the Department of Electrical Engineering, which had been held once a week on Tuesday since around 1920. Minutes of the meetings had been distributed to researchers outside of the University via various routes and therefore some of them had been referred to as 'Records of Tuesday Electrical Engineering Conversatione Tôhoku University' with the result that they came to be treated as official publications.

Though the meeting was once interrupted by World War Two, it was restarted in 1947. In 1952, the publication of the records was succeeded by the Institute and the records have been published as periodicals, two times a year recently, since No. 1 Vol. 21 was published in July, 1952.

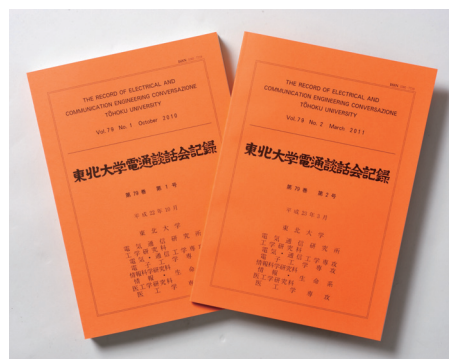

2. The Annual Report of Research Activity at the Research Institute of Electrical Communication, Tohoku University

Published annually since 1995. This report details the activities of each research division and research facility. Also included are reports on nation-wide co-operative research projects, international symposium and seminars organized by members of RIEC, and the reports and evaluation on the RIEC advisory board members. English version is also available since 2007.



Educational Activities

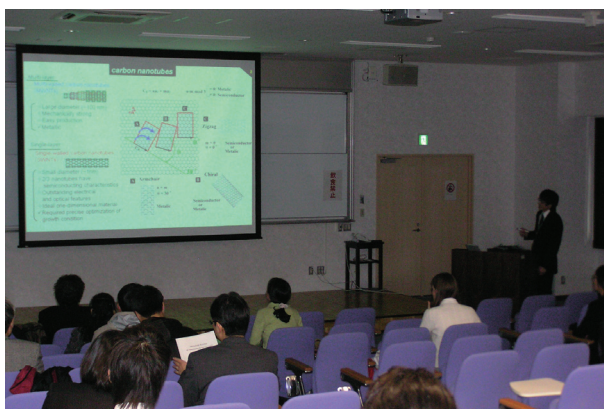

Presentation scene at a workshop



Seminar scene at a laboratory



Marathon relay race



Weed out-the-garden-and-Drink-beer-there Meeting

RIEC is keeping close contact with the School of Engineering, Graduate School of Information Sciences, and Graduate School of Biomedical Engineering. All faculty members of RIEC hold positions in these schools and have courses for graduate and undergraduate students. Students also have chances to join the research groups in RIEC. In 2011, 40 undergraduate students, 145 master course students, and 56 doctor course students are studying at RIEC.

RIEC also receives many visiting professors, visiting scholars, visiting students, and postdoc researchers from all over the world.

International Activities

Many of the staff in RIEC contribute to the development of technology and science in the world by serving as editors or referees of international journals or by chairing or programming international conferences. In some fields in electronics, electrical communications, or information engineering RIEC serves as a Center of Excellence(COE), which attracts many visiting researchers and students from all over the world every year. Several academic exchange programs with foreign colleges or institutes are in operation.

International academic exchange programs:

The Institute of Physics, Polish Academy of Sciences (Poland)
The Interdisciplinary Center on Nanoscience of Marseille, National Center of Scientific Research (France)
IHP-Innovations for High Performance microelectronics (Germany)
Institute of Semiconductors Chinese Academy of Sciences (China)
WINLAB, Rutgers University (U.S.A)
University of California, Santa Barbara (U.S.A.)
King Mongkut's Institute of Technology Ladkrabang (Thailand)
The University of York (U.K.)
The Dresden University of Technology (Germany)
Berlin Institute of Technology (Germany)
National Tsing Hua University (Taiwan)
Universite de Technologie de Compiègne (France)
Harvard University (U.S.A.)
University of Vigo (Spain)

International journals in which a staff in RIEC participates as an editor:

1. Higher-order and symbolic computation
2. International Journal of Energy, Information and Communications
3. International Journal of Artificial Intelligence, Neural Networks, and Complex Problem Solving technologies
4. International Journal of Computer Science and Network Security
5. International Journal of Information Sciences and Computer Engineering (IJISCE)
6. SICE Journal of Control, Measurement, and System Integration
7. Journal of Communications and Networks
8. Virtual Journal of Nanoscale Science and Technology
9. NPG Asia Materials
10. Journal of Magnetism (Korean Magnetism Society)
11. Journal of SPIN

12. Nature Communications
13. The Journal of Computer Animation and Virtual Worlds
14. Japanese Journal of Applied Physics
15. Applied Acoustics
16. Acoustical Science and Technology
17. Nonlinear Theory and Its Applications, ZEZCE
18. International Journal of Wireless Information Networks
19. Optical Fiber Technology

International conferences programmed by a staff in RIEC:

1. 3rd Semiconductor Technology for Ultra Large Scale Integrated Circuits and Thin Film Transistors (ULSIC vs. TFT)
2. 7th International Conference on Silicon Epitaxy and Heterostructures (ICSI-7)
3. Symp.E9: "ULSI Process Integration 7", 220th Meeting of the Electrochem. Soc
4. 2011 Conference on Lasers and electro-Optics (CLEO2011)
5. 16th OotoElectronics and Communications Conference (OECC2011)
6. 2010 Asia-Pacific Microwave Conference (APMC2010)
7. 6th International ICST Conference on Cognitive Radio
8. Oriented Wireless Networks and Communications (Crown Com 2011)
9. The 2010 IEEE/WIC/ACM International Joint Conference on Web Intelligence and Intelligent Agent Technology
10. International Conference on knowledge Engineering and Ontology Development 2010
11. The 22nd International Conference Industrial & Engineering Applications of Artif. Intell. & Exp. Systems (IEA/AIE 2010)
12. The 5th International Conference on Ubiquitous

- Information Technologies & Applications (CUTE2010)
13. The 4th International Conference on Complex, Intelligent and Software Intensive Systems (CISIS 2010)
 14. The 5th International Symposium on Adaptive Motion of Animals and Machines
 15. SPIE International Conference on Defence, Security, and Sensing
 16. Topical Workshop on Heterostructure Microelectronics (TWHM)
 17. Asia- Pacific Workshop on Fundamentals and Applications of Advanced Semiconductor Devices (AWAD)
 18. International Conference on Optical Terahertz Science and Technology (OTST)
 19. 11th International Conference on Atomically Controlled Surfaces, Interfaces and Nanostructures (ACSIN)
 20. 4th International Conference on Smart materials, Structures and Systems (CIMTC)
 21. 16th International Conference on Solid Films and Surfaces (ICSFS)
 22. European Solid-State Device Research Conference (ESSDERC)
 23. SPIE Photonics West, Conference OE01
 24. IQEC/CLEO Pacific Rim, Program Subcommittee (Quantum Information and Cryptography)
 25. 2011 Spintronics Workshop on LSI
 26. 15th International Symposium on the Physics of Semiconductors and Applications (ISPSA-XV)
 27. 6th International School and Conference on Spintronics and Quantum Information Technology (SPINTECH 6)
 28. International Conference on Superlattices, Nanostructures, and Nanodevices (ICSNN)
 29. International Conference of Magnetism (ICM)
 30. Asia Pacific Vision Conference 2011
 31. International Multisensory Research Forum 2011
 32. 10th Asia Pacific Conference on Computer Human Interaction (APCHI)
 33. 6th Annual ACM Conference on interactive Tabletops and Surfaces (ITS2011)
 34. 6th Advances in Computer Entertainment Technology Conference (ACE2010)
 35. ACM Symposium on Virtual Reality Software and Technology (VRST)
 36. IEEE Symposium on 3D User Interfaces (3DUI)
 37. IEEE International Symposium on Multiple-Valued Logic
 38. International Symposium on Low Power Electronics and Design
 39. 6th International Symposium on Control of Semiconductor Interfaces (ISCSI-VI)
 40. International Multisensory Research Forum (IMRF) 2011
 41. Inter-noise 2011
 42. International Symposium on Nonlinear Theory and its Applications
 43. 6th International Workshop on Nanoscale Spectroscopy and Nanotechnology
 44. Personal, Indoor and Mobile Radio Communications (PIMRC)
 45. Global Symposium on Millimeter Waves (GSMM) 2012
 46. Magnetism and Magnetic Materials (MMM)
 47. Intermag
 48. European Conference on Optical Communication

RIEC Open Day

Every year RIEC holds an open day to present our research and educational activities to public, including university staffs, students and alumni as well as representative from industry.

In 2010, the RIEC Open Day was taken place on Saturday 9th and Sunday 10th of October. All the research laboratories, research centers, and machine shops of RIEC exhibited various types of demonstrations focused on their research fields.

Exhibition included some historical devices and instruments developed in RIEC, such as magnetron tubes and steel recorders, as milestones of the RIEC activities. On the other hand, experiments on cutting-edge researches were also demonstrated, such as ultra-high speed optical fiber data transmission, mixed-signal integrated circuits, computer-aided design of materials, and operation of micro-machines. Furthermore, visitors were able to join handicraft courses for some simple electronic gadgets such as germanium radios, piezoelectric speakers, and so on.

In 2011, the RIEC Open Day will be held on Saturday 8th and Sunday 9th of October. Your participation is greatly welcomed.

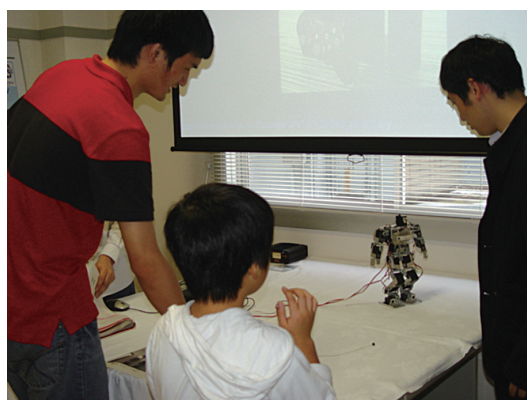
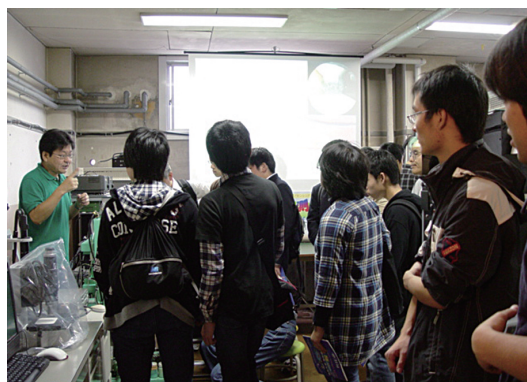
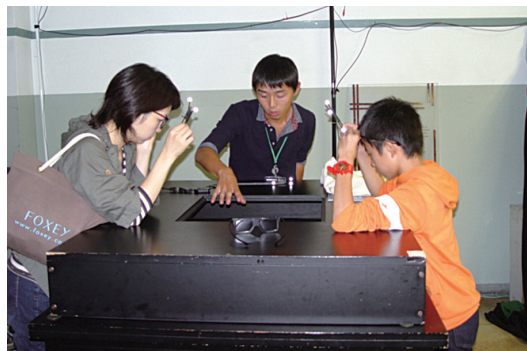

Staff

(as of 1st July 2011)

Director: Masataka NAKAZAWA, Professor

■ Research Divisions

Information Devices Division

- **Nano-photoelectronics**

Yoichi UEHARA, Professor
Satoshi KATANO, Assistant Professor

- **Quantum-optical Information Technology**

Keiichi EDAMATSU, Professor
Mitsuyuki NAKAO, Professor*
Hideo KOSAKA, Associate Professor
Yasuyoshi MITSUMORI, Associate Professor
Norihiko KATAYAMA, Associate Professor*

- **Solid State Electronics**

Maki SUEMITSU, Professor
Koji KOTANI, Associate Professor*
Hirokazu FUKIDOME, Assistant Professor
Roland VINO BANTACULO, Research Fellow

- **Dielectric Nano-Devices**

Yasuo CHO, Professor
Sinichiro UMEMURA, Professor*
Yoshiomi HIRANAGA, Assistant Professor
Kohei YAMASUE, Assistant Professor
Yasuo WAGATSUMA, Technical Official
Toshihiko IWAI, Technical Official

- **Plasma Electronics**

Akira ANDO, Professor*
Satoru IIZUKA, Associate Professor*

- **Materials Functionality Design**

Masafumi SHIRAI, Professor
Kazuyuki TANAKA, Professor*

Yuji WAIZUMI, Lecturer*
Yoshio MIURA, Assistant Professor
Kazutaka ABE, Assistant Professor
Masahito TSUJIKAWA, Research Fellow

- **Magnetic Devices (Visitor Section)**

Masahide SASAKI, Visiting Professor
Koichiro HONDA, Visiting Professor
Hiroyuki KAGESHIMA, Visiting Professor
Daiji FUKUDA, Visiting Associate Professor

Broadband Engineering Division

- **Ultrahigh-speed Optical Communication**

Masataka NAKAZAWA, Professor
Junji TADA, Designated Professor
Hirohito YAMADA, Designated Professor*
Yuji MATSUURA, Designated Professor*
Toshihiko HIROOKA, Associate Professor
Masato YOSHIDA, Associate Professor
Yasuo OHDERA, Associate Professor*
Keisuke KASAI, Research Fellow

- **Applied Quantum Optics**

Hiroshi YASAKA, Professor
Takashi WATANABE, Associate Professor*

- **Wireless Info Tech**

Noriharu SUEMATSU, Professor
Jun-ichi KUSHIBIKI, Professor*
Suguru KAMEDA, Assistant Professor
Shoichi TANIFUJI, Research Fellow

- **Information Storage Systems**

Hiroaki MURAOKA, Professor
Xiao ZHOU, Professor*
Simon J. GREAVES, Associate Professor
Kenji MIURA, Assistant Professor

- **Ultra-Broadband Signal Processing**

Taiichi OTSUJI, Professor
Fumiyuki ADACHI, Professor*
Tetsuya SUEMITSU, Associate Professor
Akira SATO, Assistant Professor
Susumu TAKABAYASHI, Research Fellow
Stephane Albon BOUBANGA TOMBET, Research Fellow

- **Basic Technology for Broadband Communication (Visitor Section)**

Masaaki INUTAKE, Visiting Professor
Noboru IZUKA, Visiting Professor
Atsufumi HIROHATA, Visiting Associate Professor

Human Information Systems Division

- **Electromagnetic Bioinformation Engineering**

Kazushi ISHIYAMA, Professor
Kotaro HAMASHIMA, Professor*
Masahiro YAMAGUCHI, Professor*
Shuichiro HASHI, Associate Professor
Satoru TSUDA, Associate Professor*
Yasushi ENDO, Associate Professor*

- **Advanced Acoustic Information Systems**

Yôiti SUZUKI, Professor
Hiroshi KANAI, Professor*
Akinori ITO, Professor*
Yukio IWAYA, Associate Professor
Shuichi SAKAMOTO, Associate Professor
Hideyuki HASEGAWA, Associate Professor*
Masakazu KAWASHITA Associate Professor*
Fumitaka SAITO, Technical Official
Zhenglie CUI, Research Fellow
Akio HONDA, Research Fellow
Hiroshi SHIBATA, Research Fellow

- **Visual Cognition and Systems**

Satoshi SHIOIRI, Professor
Makoto YOSHIZAWA, Professor*
Ichiro KURIKI, Associate Professor
Noriyasu HOMMA, Associate professor*
Kazumichi MATSUMIYA, Assistant Professor
Rumi TOKUNAGA, Assistant Professor
Mitsuharu OGIYA, Research Fellow
Kazuya MATSUBARA, Research Fellow
Ryoichi NAKAJIMA, Research Fellow

- **Ubiquitous Communications System**

Shuzo KATO, Professor
Kunio SAWAYA, Professor*
Hiroyuki NAKASE, Associate Professor
Qiang CHEN, Associate Professor*
Hirokazu SAWADA, Assistant Professor
Lawrence Yasay MATERUM, Research Fellow

- **Multimodal Computing (Visitor Section)**

Nobuyoshi KOSHIDA, Visiting Professor
Masato MIYOSHI, Visiting Professor
Ryuichi NISHIMURA, Visiting Associate Professor

Systems & Software Division

- **Software Construction**

Atsushi OHORI, Professor
Naoki KOBAYASHI, Professor*
Eijiro SUMII, Associate Professor*
Katsuhiro UENO, Assistant Professor
Akimasa MORIHATA, Assistant Professor

- **Computing Information Theory**

Yoshihito TOYAMA, Professor
Hiroki SHIZUYA, Professor*
Ayumi,SHINOHARA, Professor*

Shinichiro OMACHI, Professor*
Takahito AOTO, Associate Professor
Masao SAKAI, Lecturer*
Kentaro KIKUCHI, Assistant Professor

- **Communication Network Systems**

Tetsuo KINOSHITA, Professor
Hiroumi SAITO, Professor*
Hideaki SONE, Professor*
Kentaro INUI, Professor*
Takaaki MIZUKI, Associate Professor*
Hideyuki TAKAHASHI, Assistant Professor

- **Information Content**

Yoshifumi KITAMURA, Professor
Nei KATO, Professor*
Takuo SUGANUMA, Professor*
Toru ABE, Associate Professor*
Terumasa AOKI, Associate Professor*
Kazuki TAKASHIMA, Assistant Professor
Gendai LIU, Research Fellow

- **Information Social Structure (Visitor Section)**

Hiroshi MATSUOKA, Visiting Professor
Masafumi YANO, Visiting Professor
Norio SHIRATORI, Visiting Professor
Sriram SUBRAMANIAN, Visiting Professor
Takana KAHO, Visiting Associate Professor

Sponsored Division

- **Environmental-Adaptive Information and Communication Engineering**

Eiki ADACHI, Professor

■ Research Facilities

Laboratory for Nanoelectronics and Spintronics

Director : Junichi MUROTA, Professor
Ryutaro SASAKI, Technical Official
Sadao TSUCHIDA, Technical Official
Toshiyasu MEGURO, Research Fellow
Yotaro NISHIMURA, Research Fellow

- **Atomically Controlled Processing**

Junichi MUROTA, Professor
Michitaka KAMEYAMA, Professor*
Shigetoshi SUGAWA, Professor*
Masao SAKURABA, Associate Professor
Masanori HARIYAMA, Associate Professor*
Yohei CHIBA, Research Fellow

- **Semiconductor Spintronics**

Hideo OHNO, Professor
Migaku TAKAHASHI, Professor*
Masashi SAHASHI, Professor*
Yuzo OHNO, Associate Professor
Fumihito MATSUKURA, Associate Professor
Masakiyo TSUNODA, Associate Professor*
Masaaki DOI, Associate Professor*
Keita OHTANI, Assistant Professor

- **Nano-Molecular Devices**

Michio NIWANO, Professor
Rikizo HATAKEYAMA, Professor*
Tatsuo YOSHINOBU, Professor*
Kengo KINOSHITA, Professor*
Yasuo KIMURA, Associate Professor
Toshiro KANEKO, Associate Professor*
Ayumi HIRANO, Associate Professor*
Nobuyuki SATO, Assistant Professor
Yuki AONUMA, Assistant Professor
Mohammad Maksudur RAHMAN, Research Fellow

- **Nano-Spin Memory**

Yasuo ANDO, Professor*
Tetsuo ENDOH, Professor*
Tetsu TANAKA, Professor*
Shoji IKEDA, Associate Professor
Mikihiko OOGANE, Assistant Professor*

Laboratory for Brainware Systems

Director : Koji NAKAJIMA, Professor

- **Real-World Computing**

Akio ISHIGURO, Professor
Hidetoshi MATSUKI, Professor*
Fumihiro SATO, Associate Professor*
Kazuhiro SAKAMOTO, Assistant Professor
Dai OWAKI, Assistant Professor
Takeshi KANO, Assistant Professor
Takahide SATO, Research Fellow
Wataru WATANABE, Research Fellow

- **Intelligent Nano-Integration System**

Koji NAKAJIMA, Professor
Masayuki KAWAMATA, Professor*
Shigeo SATO, Associate Professor
Masahide ABE, Associate Professor*
Takeshi ONOMI, Assistant Professor

- **Microarchitecture**

Shoichi MASUI, Professor

- **New Paradigm VLSI System**

Takahiro HANYU, Professor
Osamu ICHINOKURA, Professor*
Takafumi AOKI, Professor*
Kenji NAKAMURA, Associate Professor*
Naofumi HOMMA, Associate Professor*
Atsushi MATSUMOTO, Assistant Professor
Masanori NATSUI, Assistant Professor

Research Center for 21st Century Information Technology

Director : Hiroaki MURAOKA, Professor

- **Project Planning Division**

Makoto FURUNISHI, Visiting Professor

- **Technology Development Division**

- ▲ **Mobile Wireless Technology Group**

Kazuo TSUBOUCHI, Visiting Professor
Tadashi TAKAGI, Visiting Professor

- ▲ **Storage Technology Group**

Kazuhisa FUJIMOTO, Professor
Hajime AOI, Visiting Professor
Koki TAKANASHI, Professor*
Osamu KITAKAMI, Professor*
Takehito SHIMATSU, Associate Professor
Kiyoshi YAMAKAWA, Visiting Associate Professor
Satoshi OKAMOTO, Associate Professor*
Nobuaki KIKUCHI, Assistant Professor*

■ Management Office for Safety and Health

Manager : Michio NIWANO, Professor
Deputy Manager : Yoichi UEHARA, Professor
Nobuyuki SATO, Assistant Professor

■ Common Research Facilities

- **Flexible Information System Research Center**

Director : Yōiti SUZUKI, Professor
Yoshihito TOYAMA, Professor*
Takuo SUGANUMA, Professor*
Gen KITAGATA, Associate Professor
Kazuto SASAI, Assistant Professor
Johan Leif Arne SVEHOLM, Research Fellow

■ Fundamental Technology Center

Director : Yoichi UEHARA, Professor

Fumitaka SAITO, Technical Official

• Machine Shop Division

Tamotsu SUENAGA, Technical Official

Keisuke SATO, Technical Official

Kento ABE, Technical Official

Ryuji YONEZAWA, Technical Official

Hiroshi WATANABE, Technical Official

Munetomo SUGAWARA, Technical Official

• Evaluation Division

Koichi SHOJI, Technical Official

Maho ABE, Technical Official

Yuji KONNO, Technical Official

Sadao TSUCHIDA, Technical Official

Shigeto AGATSUMA, Technical Official

• Process Division

Katsumi SAGAE, Technical Official

Ryutaro SASAKI, Technical Official

Choichi TAKYU, Technical Official

Yasuo WAGATSUMA, Technical Official

• Software Technology Division

Fumitaka SAITO, Technical Official

Masahiko SATO, Technical Official

*Joint Appointment

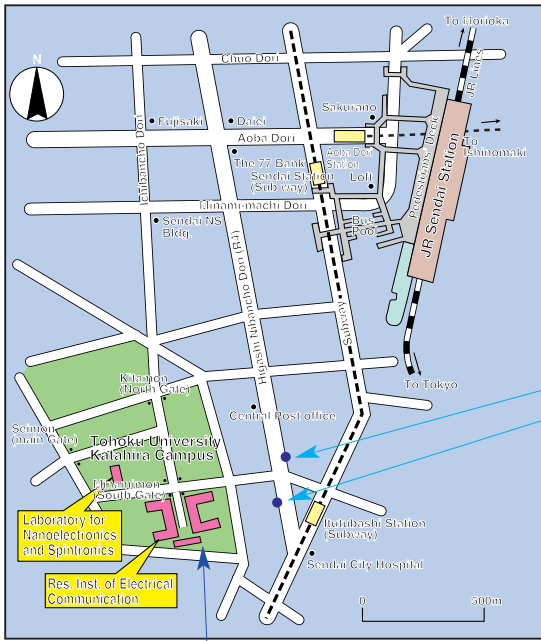
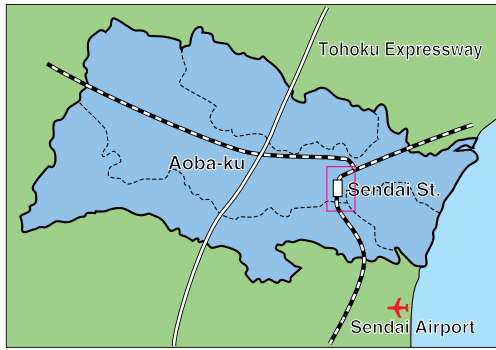



**Research Institute of Electrical Communication
Tohoku University**

2-1-1 Katahira, Aoba-ku, Sendai 980-8577, JAPAN TEL (022)217-5420 FAX (022)217-5426

<http://www.riec.tohoku.ac.jp>