



Annual Report 2015

Annual Report 2015

Research Institute of Electrical Communication
Tohoku University



Research Institute of Electrical Communication
Tohoku University

2-1-1 Katahira, Aobaku, Sendai 980-8577, Japan
Tel. +81-(0)22-217-5420 Fax. +81-(0)22-217-5426
<http://www.riec.tohoku.ac.jp>

Research Institute of Electrical Communication Tohoku University



Annual report of Research Institute of Electrical Communication 2015

Contents

1. Introduction	1
2. Organization Chart	5
3. Research Activities	7
Research Divisions	
• Information Devices Division	7
• Broadband Engineering Division	13
• Human Information Systems Division	20
• Systems & Software Division	25
Laboratories and Centers	
• Laboratory for Nanoelectronics and Spintronics	31
• Laboratory for Brainware Systems	39
• Research Center for 21st Century Information Technology	44
• Management Office for Safety and Health	47
• Flexible Information System Center	48
• Fundamental Technology Center	49
• Ad-hoc research groups	50
Related Organizations and Programs, etc.	
• Center for Spintronics Integrated Systems	51
• Research Organization of Electrical Communication	52
• Center for Innovative Integrated Electronics Systems	53
• Spintronics Research and Education Promotion Office	55
• Leading Graduate Program	56
• Graduate Program in Spintronics (GP-Spin)	57
• Program for Key Interdisciplinary Research	58
4. Nation-wide Cooperative Research Projects	59
5. Symposium Organized by the Institute	71
6. Study Groups on Electrical Communication	77
7. International Activities	81
8. Periodicals Published by the Institute	85
9. Staff, Budget	87

1. Introduction

Ever since the RIEC was established in 1935 based on the research of cutting-edge technologies such as Yagi-Uda antennas and magnetrons, a succession of pioneering achievements from the institute have laid the foundations of information science and communications technology. Today, the RIEC continues to play a world-leading role. Last year we celebrated not only the institute's 80th anniversary but also the completion of construction of the institute's main building, with its six floors, basement, and 13,513 square meters of total floor space, with commemorative and opening ceremonies. On this occasion, we reflected on the words of then institute director Junichi Nishizawa, spoken at the institute's 50th anniversary celebration: "Scholarship requires us to study phenomena that not even yet have a name. This spirit shall form the foundation of the Research Institute of Electrical Communication and the Electrical Engineering Group, Tohoku University." Building on this tradition, we will continue working to lead the world in the advancement and evolution of science and technology to realize new ways of communication that enrich people's lives.

The environment in which Tohoku University and the RIEC operate is constantly changing. The current fiscal year marks the first year of the Japan's Fifth Science and Technology Basic Plan, which aims to realize a cycle of innovation toward a super-smart society. The plan sets out policies for strengthening the fundamental technologies that will support this, including cyber security, the "Internet of things," big data, artificial intelligence, and devices. It goes without saying that these research fields fall under the RIEC's scope of expertise and that the institute must play a leading role in their furtherment. Meanwhile, the current fiscal year is also the initial year of the Third Mid-term Planning Period for National Universities. Operating grants have been reduced, reflecting Japan's fiscal circumstances, while the content has also shifted, with universities required to make major reforms spanning education, research, and collaboration with industry. It is in this environment that we must work to develop communications technologies, including the aforementioned fundamental technologies.

Since 2004, the institute's organizational structure has been organized into three units: four research divisions (Information Devices Division, Broadband Engineering Division, Human Information Systems Division, and Systems & Software Division), two laboratories (Laboratory for Nanoelectronics and Spintronics, and Laboratory for Brainware Systems), and the Research Center for 21st Century Information Technology. These units are engaged in research aimed at achieving fruition over different time scales (Research Divisions: 20 years, Laboratories: 10 years, Research Center: 5 years). In addition, we collaborate closely with Tohoku University's graduate schools in subjects relating to electrical engineering (School of Engineering, Graduate School of Information Sciences, and Graduate School of Biomedical Engineering) in order to cover a wide range of cutting-edge research fields and foster the development of outstanding researchers and engineers.

The RIEC has also been certified by the Ministry of Education, Culture, Sports, Science and Technology as a Joint Usage/Research Center for collaborative research in information science and technology. The current fiscal year marks the initial year of the program's second term. As management expenses grants decrease, our role in advancing the information and communication community—both in Japan and overseas—will become increasingly important. To this end, we are collaborating on joint research projects with external researchers and engineers from industry, government, and academia in a systematic manner.

Today, telecommunications are an essential part of the social infrastructure. We must therefore realize faster, higher-capacity telecommunications with greater energy efficiency performance, while the experience of the Great East Japan Earthquake of 2011 reemphasized the importance of ensuring that our social infrastructure has a high resilience to disaster. We are expected to contribute to a new paradigm of information processing and communication methods that interconnect people in a fundamentally different way. At the RIEC, we will continue to address these social needs by fully leveraging our strengths as a university-affiliated research center. In doing so, we hope to forge the path to a new world of communication, and through these efforts continue to promote education going forward.

To contribute to the improvement of our research activities and support future developments, we publish this Annual Report every year to make our activities relating to research, education, and social contribution widely available for public scrutiny. This edition contains reports on a range of activities, including the research conducted by each of our departments and laboratories, collaborative research projects, international activities, social contributions, the RIEC symposium, activities of the engineering research association, and RIEC lectures. The bibliography section also includes data on the various activities we have conducted over the last five years.

We welcome your frank opinions regarding our activities, and look forward to your continued guidance and support in the future.

May 1, 2016

Director, Research Institute of Electrical Communication

A handwritten signature in black ink, appearing to read 'Hideo Ohno', with a long horizontal stroke extending to the right.

Hideo Ohno

2. Organization Chart

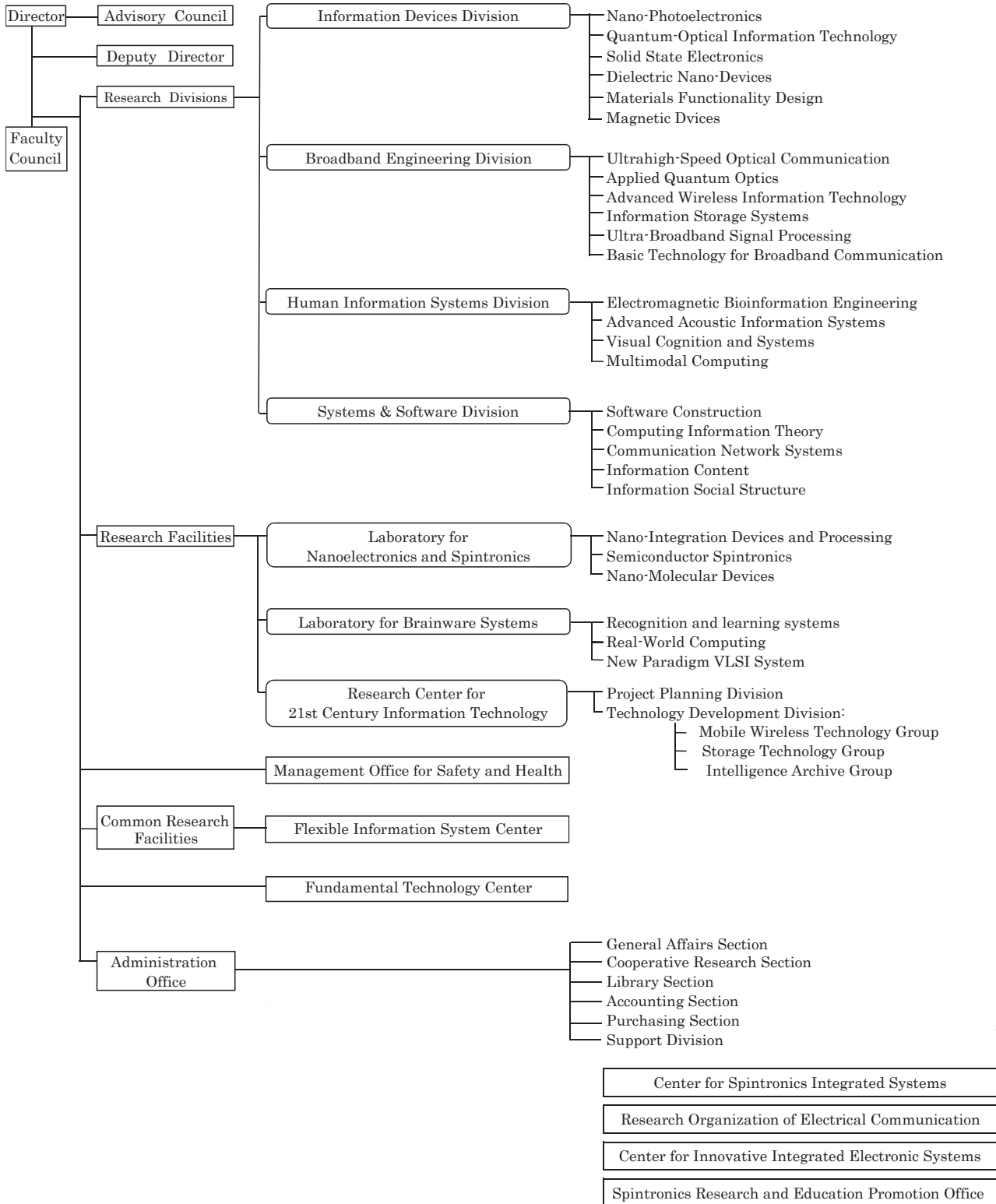

3. Research Activities

Targets and achievements of the Information Devices Division

The main aim of the information devices division is to create new materials and devices for next generation communication technology.

To accomplish this goal, we have the following 6 sub-divisions. The research fields include nano-scale photoelectronic conversions, quantum-optical information technology, novel transport properties in low-dimensional systems, new dielectrics-based nano-devices for information storage, and design of new materials having exotic functionalities. We also have a partnership with *Nano-Integration Devices and Processing* section in the Laboratory for Nanoelectronics and Spintronics.

1. Nano-Photoelectronics
2. Quantum-Optical Information Technology
3. Solid State Electronics
4. Dielectric Nano-Devices
5. Materials Functionality Design
6. Magnetic Devices (Visitor Section)

The research target and the summary of activities of each sub-division in 2015 are described in the following pages. The summary of activities of *Nano-Integration Devices and Processing* section is described in the chapter of Laboratory for Nanoelectronics and Spintronics.

Nanophotoelectronics

Exploring optical and electronic properties of nanometer-sized structures and their applications in photoelectronic devices

Nanophotoelectronics Yoichi Uehara, Professor

Nano photomolecular electronics Satoshi Katano, Associate Professor

[Research Target and Activities]

Our main interest lies in studying the physical and chemical phenomena that take place in nanometer-scale regions and their applications in nanophotoelectronic devices. The summary of our achievements in 2015 is as follows. (1) Pump-probe STM light emission spectroscopy (P-P STM-LE) with ps temporal resolution was carried out for several materials. Time evolution of dielectric function of Au after stimuli by each pump pulse was described in terms of d-band holes created by each pump pulse. Temporal behavior of vibrational modes of atomic hydrogen adsorbed on Ni(110) was observed in ps temporal and atomic spatial resolution. Individual VO₂ nanostructures showed semiconducting-metallic phase transitions after 25 ps from stimuli by each ps pump pulse. To develop P-P STM-LE in the THz spectral range, THz STM LE from Sb₂Te₃ illuminated with ps laser pulses was measured as a function of laser power. The laser power dependence of THz STM LE is ascribed to the ps temporal change of the band structure induced by each ps laser pulse, which was found by P-P STM-LE of Sb₂Te₃ in the visible spectral range. (2) The electronic and optical properties of graphene oxide (GO) are governed by the relative fraction of sp²- and sp³-hybridized domains. Although extensive efforts have been made to reveal and to control the electronic states of GO, most of studies have paid little attention to the atomic scale electronic properties so far. We have investigated local electronic structures of GO using STS. The position-dependent STS measurement revealed the spatial distribution of sp² domains in GO. (3) We have investigated the creation and optical properties of a single Ag nanoparticle (AgNP) on Si(111) using STM light emission spectroscopy. The peak intensity of STM light emission increases with increasing the size of AgNP, accompanying the shift of the peak position. Obtained results are well reproduced by the theoretical calculation.

[Staff]

Professor Yoichi Uehara, Dr.
Associate Professor Satoshi Katano, Dr.

[Profile]

Dr. Yoichi Uehara obtained his D. Eng. degree from the Department of Engineering, University of Osaka prefecture in 1986, after which, he was initially appointed as an Assistant Professor at the Research Institute of Electrical Communication, Tohoku University. He eventually became a Full Professor at the institute in 2005. Dr. Uehara has worked on three main surface physics problems at Tohoku University: (1) light emission from metal-insulator-metal and metal-oxide-semiconductor (MOS) tunnel junctions, (2) low-energy electron spectroscopy, and (3) light emission spectroscopy of STM.

Dr. Satoshi Katano received his D. Sci. degree from Department of Electronic Chemistry, Tokyo Institute of Technology in 2003. He was a postdoctoral research fellow in RIKEN (2003-2006). He joined RIEC, Tohoku University as an Assistant Professor in 2006 and was promoted to an Associate Professor in 2012. His research interests include surface physical chemistry and nano-scale molecular optoelectronics.

[Papers]

- [1] Y. Uehara, S. Katano, M. Kuwahara, and T. Suzuki, "Electromagnetic Properties of Scanning Tunneling Microscope Tip-sample Gap in the Terahertz Frequency Range", *Jpn. J. Appl. Phys.*, **54**, 08LB06 (2015).
- [2] S. Katano, H. Fujita, T. Wei, and Y. Uehara, "Nanoscale Light Emission Spectroscopy of a Single Carbon Nanotube Adsorbed on Au(111)", *J. Vac. Soc. Jpn.*, **59**, 92-95 (2016).

Quantum-Optical Information Technology

Development of optoelectronic devices for quantum information and communication technology

Quantum-Optical Information Technology: Keiichi Edamatsu, Professor

Quantum Laser Spectroscopy: Yasuyoshi Mitsumori, Associate professor

Quantum Nanophotonics: Mark Sadgrove, Associate professor

[Research Target and Activities]

Our goal is to develop the quantum information devices utilizing quantum interaction between photons and electrons in solids. In 2015, we have achieved (1) experimental demonstration of error-disturbance uncertainty relations in photon polarization measurement, (2) observation of local-field effects on optical coherent transients of semiconductor quantum dots, and (3) fabrication of optical nanofibers along with the controlled introduction of single gold nanoparticles to the nanofiber surface.

[Staff]

Professor: Keiichi Edamatsu, Dr.

Associate Professor: Yasuyoshi Mitsumori, Dr.

Associate Professor: Mark Sadgrove, Dr.

[Profile]

Keiichi Edamatsu received B.S., M.S., and D.S. degrees in Physics from Tohoku University. He was a Research Associate in Faculty of Engineering, Tohoku University, a Visiting Associate in California Institute of Technology, and an Associate Professor in Graduate School of Engineering Science, Osaka University.

Yasuyoshi Mitsumori received B.S., M.S. and D.S. degrees in Applied Physics from Tokyo Institute of Technology. He was a Research Fellow of the Japan Society for the Promotion of Science, a Researcher in NTT Basic Research Laboratories, a Postdoctoral Fellow in Tokyo Institute of Technology, a Postdoctoral Fellow in Communications Research Laboratory, a Research Associate in Research Institute of Electrical Communication, Tohoku University.

Mark Sadgrove received B.S., M.S., and Ph.D degrees in science from University of Auckland. He was a Postdoctoral Fellow in The University of Electrocommunications, a Postdoctoral Fellow in Gaku-shuin University, and an Assistant Professor (nontenured) in The Center for Photonic Innovations, The University of Electrocommunications

[Papers]

- [1] J. Keloth, M. Sadgrove, R. Yalla, and K. Hakuta, "Diameter measurement of optical nanofibers using a composite photonic crystal cavity," *Opt. Lett.* 40, 4122-4125 (2015)
- [2] N. Matsumoto, K. Komori, Y. Michimura, G. Hayase, Y. Aso, and K. Tsubono, "5-mg suspended mirror driven by measurement-induced backaction," *Phys. Rev. A* 92, 033825 (2015)
- [3] K. Edamatsu, "Quantum measurement and uncertainty relations in photon polarization," *Phys. Scr.*, in press.

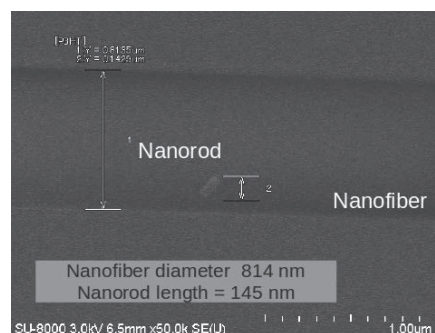

Fig. SEM image of a single gold nanoparticle (nanorod) introduced to the nanofiber surface.

Solid State Electronics Laboratory

Paving a Way for Introducing SiC, Graphene, and 2DM into Si Technology

Solid State Electronics Maki Suemitsu, Professor

Solid State Physics for Electronics Hirokazu Fukidome, Associate Professor

[Research Target and Activities]

Graphene is a 2D honeycomb network of carbon atoms. Its extremely high carrier mobility, which is ~100 times as high as that of silicon, makes graphene a dream material. We have developed a method to form an epitaxial graphene onto silicon substrates for the first time, which consists of 3C-SiC heteroepitaxy on Si and subsequent sublimation of surface Si atoms (graphene-on-Si, or GOS, technology). We are currently working on betterment of the GOS quality as well as on the development of graphene devices centered on RF field-effect transistors and optical devices.

In FY2015, we succeeded in growing extremely high quality epitaxial graphene on the C-face of SiC crystals for the first time. We developed operando analysis methods to characterize the device performance of 2D-material devices as well.

[Staff]

Professor : Maki Suemitsu, Dr.

Assistant Professor : Hirokazu Fukidome, Dr.

Visiting Professor : Hiroyuki Nagasawa, Dr.

Research Assistant : Sai Jiao, Dr.

Research Assistant : Goon-Ho Park, Dr.

Research Assistant: Venugopal Gunasekaran

Technical Assistant : Kumi Namiiri

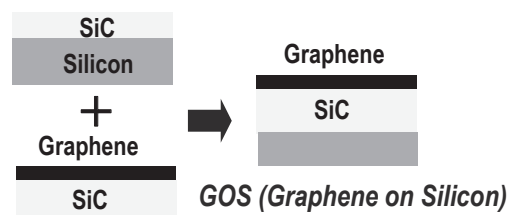

[Profile]

Prof. Maki Suemitsu received Ph.D on electronic engineering from Tohoku University in 1980. He started his service at Research Institute of Electrical Communication (RIEC) in 1980, became associate professor in 1990, and became professor at Center for Interdisciplinary Research, Tohoku University in 2003. Since 2008, he has been professor at RIEC. He has been engaged mainly on surfaces of semiconductor thin films. He was awarded the 30 th Kumagai prize of the best paper from the Vacuum Society of Japan (2005) and the Best Paper Award from the Surface Science Society of Japan (2011).

Prof. Hirokazu Fukidome received Ph.D on chemistry from Osaka University. After serving for Bell Labs and RIKEN, he became assistant professor at RIEC in 2008. He has been associate professor at RIEC since 2012. He has been engaged on two-dimensional Dirac electron systems and their operando-microscopy analysis. He was awarded the Best Paper Award from the Surface Science Society of Japan (2011).

[Papers]

- [1] Kohei Yamasue, Hirokazu Fukidome, Kazutoshi Funakubo, Maki Suemitsu, and Yasuo Cho, "Interfacial Charge States in Graphene on SiC Studied by Noncontact Scanning Nonlinear Dielectric Potentiometry," *Physical Review Letters*, Vol. 114, 226103-1-5, 2015.
- [2] Sai Jiao, Yuya Murakami, Hiroyuki Nagasawa, Hirokazu Fukidome, Isao Makabe, Yasunori Tateno, Takashi Nakabayashi, and Maki Suemitsu, "High quality graphene formation on 3C-SiC/4H-AlN/Si heterostructure," *Materials Science Forum*, Vol. 806, No. , pp. 89-93, 2015.
- [3] Hiroyuki Nagasawa, Ramya Gurunathan, Maki Suemitsu, "Controlling Planar Defects in 3C-SiC: Ways to Wake it up as a Practical Semiconductor," *Materials Science Forum*, Vol. 821-823, pp.108-114, 2015.

Dielectric Nano-Devices

Research on Dielectric Nano Science and Technology

Dielectric Nano-Devices Yasuo CHO, Professor

[Research Target and Activities]

Our main area of interest is evaluation and development of dielectric materials, including ferroelectric and piezoelectric materials and their application to communication devices and ferroelectric data storage systems. Our major contributions to advancement in these fields are the invention and the development of “Scanning Nonlinear Dielectric Microscope” (SNDM) which is the first successful purely electrical method for observing the ferroelectric polarization distribution without the influence of the shielding effect by free charges and it has already been put into practical use. The resolution of the microscope has been improved up to atomic scale-order. Therefore, it has a great potential for realizing the ultra-high density ferroelectric recording system.

Major achievements of studies in 2015 are as follows: (1) Graphene on 4H-SiC(0001) was observed using noncontact scanning nonlinear dielectric potentiometry (NC-SNDP) with an atomic resolution. Additionally, we proposed a novel method for observing surface spontaneous polarization using NC-SNDP. (2) SiO₂/SiC interfaces were characterized using super-higher-order nonlinear dielectric microscopy. Additionally, we developed local DLTS as a novel method for characterization of interfaces in semiconductor devices. (3) Nanoscaled domain inversion on yttrium doped HfO₂ thin films was studied using SNDM for developing novel recording media of ferroelectric probe data storage technology. (4) We proposed a novel method for nanoscale linear permittivity imaging based on SNDM.

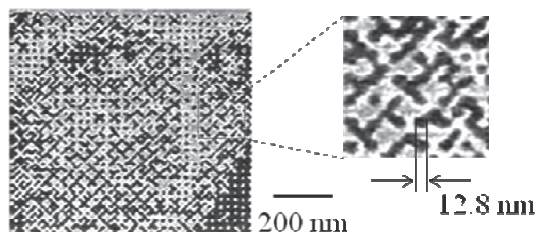

Fig.1 Digital bit data written on ferroelectric single crystal with the areal recording density of 4 Tbit/inch².

[Staff]

Professor : Yasuo Cho, Dr.

Assistant Professor : Kohei Yamasue, Dr.

Assistant Professor : Yoshiomi Hiranaga, Dr.

[Profile]

Yasuo Cho graduated in 1980 from Tohoku University in electrical engineering department. In 1985 he became a research associate at Research Institute of Electrical Communication Tohoku University. In 1990, he received an associate professorship from Yamaguchi University. He then became an associate professor in 1997 and a full professor in 2001 at Research Institute of Electrical Communication Tohoku University. During this time, his main research interests included nonlinear phenomena in ferroelectric materials and their applications, research on the scanning nonlinear dielectric microscope, and research on using the nonlinear dielectric microscope in next-generation ultrahigh density ferroelectric data storage (SNDM ferroelectric probe memory).

[Papers]

- [1] K. Yamasue, H. Fukidome, K. Funakubo, M. Suemitsu and Y. Cho, “Interfacial Charge States in Graphene on SiC Studied by Noncontact Scanning Nonlinear Dielectric Potentiometry”, *Phys. Rev. Lett.*, Vol. 114, p. 226103, 2015
- [2] M. Suzuki, K. Yamasue, and Y. Cho, “Experimental study of electric dipoles on an oxygen-adsorbed Si(100)-2×1 surface by non-contact scanning nonlinear dielectric microscopy”, *Appl. Phys. Lett.*, Vol. 107, p. 031604, 2015
- [3] K. Yamasue and Y. Cho, “Scanning nonlinear dielectric potentiometry”, *Rev. Sci. Instrum.*, Vol. 86, p. 093704, 2015

Materials Functionality Design

Computational Design of Functional Materials for Spintornics

Materials Functionality Design: Masafumi Shirai, Professor

[Research Target and Activities]

Our research targets are as follows: (1) theoretical analyses of quantum phenomena which appear in materials and nanostructures for advanced information devices, (2) computational design of materials and nanostructures which possess new functionalities for improvement of device performance, and (3) development of new design procedures based on large-scale computational simulation techniques.

Our research activities in FY 2015 are as follows:

(1) Theoretical design of electrode materials for magnetic tunnel junctions (MTJ)

We investigated the magnetic properties of $DO_{22}Mn_3Ga$ doped with Ti, V, and Cr, by using first-principles calculations. While the magnetization is increased by the doping, the uniaxial magnetic anisotropy energy K_u is slightly decreased (see Fig. 1). The Ti- or V-doped Mn_3Ga alloy is promising candidates for electrode materials of MgO-based MTJ since the Δ_1 band is completely spin-polarized.

(2) Electronic structure of shape memory alloys

We investigated electronic structure of shape memory alloys Ni-Mn-In by means of hard x-ray photoelectron spectroscopy and first-principles calculations. We found a sharp drop in the density of states near the Fermi-level below the structural transformation temperature. The structural transformation is related to a competition of magnetic coupling between Mn atoms in Ni-Mn-In [2].

[Staff]

Professor: Masafumi Shirai, Dr.

Assistant Professor: Kazutaka Abe, Dr.

Assistant Professor: Masahito Tsujikawa, Dr.

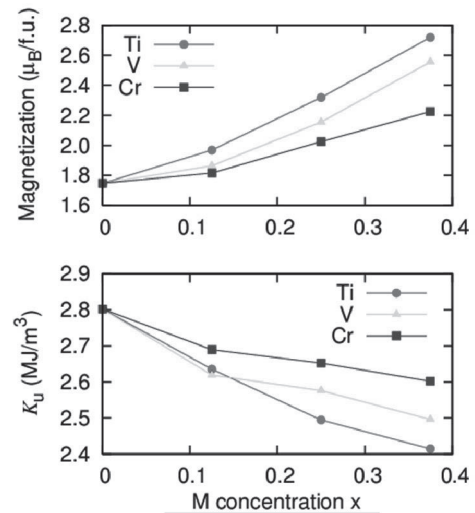

Fig. 1

[Profile]

Masafumi Shirai received the Doctor of Engineering degree from Osaka University in 1989. From 1988 to 1996, he was a Research Associate, and then, from 1996 to 2002, an Associate Professor at Osaka University. From 2002 to the present, he has been a Professor at Tohoku University. Now his research interest is focused on computational design of functional materials for spintronics devices.

[Papers]

- [1] V. R. Singh, V. K. Verma, K. Ishigami, G. Shibata, A. Fujimori, T. Koide, Y. Miura, M. Shirai, T. Ishikawa, G.-f. Li, and M. Yamamoto, "Electronic and magnetic properties of off-stoichiometric Co_2Mn_6Si/MgO interfaces studied by x-ray magnetic circular dichroism," *J. Appl. Phys.*, Vol. 117, No. 20, Article No. 203901, pp. 1-6, 2015
- [2] S. Zhu, M. Ye, K. Shirai, M. Taniguchi, S. Ueda, Y. Miura, M. Shirai, R. Y. Umetsu, R. Kainuma, T. Kanomata, and A. Kimura, "Drastic change in density of states upon martensitic phase transition for metamagnetic shape memory alloy $Ni_2Mn_{1+x}In_{1-x}$," *J. Phys.: Condens. Matter*, Vol. 27, No. 36, Article No. 362201, pp. 1-6, 2015
- [3] Kazutaka Abe and N. W. Ashcroft, "Stabilization and highly metallic properties of heavy group-V hydrides at high pressures," *Phys. Rev. B*, Vol. 92, No. 22, Article No. 224109, pp. 1-5, 2015

Broadband Engineering Division: Research Target and Results

In order to establish the future broadband communication systems and novel devices that are flexibly applied to the future ubiquitous ultra-large capacity information communication, research and development are carrying out over the wide bands of microwaves, millimeter/submillimeter waves, terahertz waves, and lightwaves with regard to the information generation, transmission, processing, and storage technologies.

(1) Advanced Wireless Information Technology

We are actively engaged in the research work on the dependable wireless information technologies for the next generation wireless systems which include terrestrial / satellite communications. We cover the whole technical fields from the lower to higher layers, i.e., signal processing, RF/Mixed signal device, antenna, MODEM and network technologies. We have developed location-based interference control method for heterogeneous wireless networks. The virtual sector method was proposed to solve the hidden and exposed node problems. We have also developed RF-IC and modules like sample-and-hold circuit for high speed and low power wireless communication system.

(2) Ultra-Broadband Signal Processing

We are developing novel, integrated electron devices and circuit systems operating in the terahertz region. One of our major concerns is a new material called “graphene”, a single-layered honeycomb-lattice carbon crystal.

First, towards the creation of novel current-injection graphene THz laser-transistors, we developed an ultrafast graphene laser-transistor device process technology demonstrating extremely high electric-field carrier mobility around 200,000 cm²/Vs an order of magnitude larger than conventional data. Another important achievement is on high-speed, high-power, high-electron-mobility transistors (HEMTs) based on InGaAs- and GaN-based quantum-well heterostructures. Improved breakdown-voltage performances were verified in GaN-based HEMTs by introducing a unique slant field plate structure integrated with the gate electrode.

(3) Ultrahigh-Speed Optical Communication

To achieve a global high-capacity optical network, we have been engaging in the research on ultrahigh-speed Optical Time-Division Multiplexing (OTDM) transmission and highly spectral-efficient coherent Quadrature Amplitude Modulation (QAM) transmission.

This year, we successfully demonstrated a single-channel 2.56 Tbit/s transmission

over 500 km using non-coherent Nyquist pulses. In addition, we realized a single-channel 1.92 Tbit/s, 64 QAM transmission using coherent Nyquist pulses with a spectral efficiency as high as 10.6 bit/s/Hz. Furthermore, we proposed a new quantum noise cipher transmission technique based on QAM, and achieved a 40 Gbit/s-480 km digital coherent transmission with extremely high security.

(4) Applied Quantum Optics

Novel functional semiconductor photonic devices including photonic integrated circuits are being investigated to explore new-generation photonic network systems.

The study on ultra-high-speed semiconductor laser with external cavity is being continued. It was confirmed that the frequency response characteristic of a laser diode can be controlled by introducing a hybrid modulation scheme which modulates cavity loss and injection current simultaneously. The scheme will contribute to enhance a laser diode response bandwidth drastically by collaborating with photon-photon resonance effect from external cavity. For the study of narrow linewidth semiconductor laser, it was confirmed that the phase noise of the semiconductor laser can be reduced up to some GHz by applying the optical negative feedback we proposed. Furthermore, it was confirmed that very flat (< 0.5 dB) 13-ch optical frequency comb was able to be generated by harmonic superposition of RF signals to the LN Mach Zehnder modulator.

(5) Information Storage Systems

Research on next-generation perpendicular magnetic recording is carrying out for high density data storage to meet the strong demand of rapid information increase in the Internet, and storage system technology as well.

We have unveiled that areal density of 5 Tbit/inch², which is five times of the current density, is achieved by the novel perpendicular recording with bit-patterned media in association with thermal assist recording technique. Storage system technology to enhance the data transfer rate was also developed. Multi-track recording with an array head is investigated from the viewpoint of fast data transfer and high areal densities. Two-dimensional magnetic recording is developed to read two tracks simultaneously with a reader to double the data transfer rate.

Research Laboratory of Ultrahigh-Speed Optical Communication

Advanced optical communication technologies approaching the Shannon limit

Research Area of Optical Transmission

Masataka Nakazawa, Professor

Research Area of Optical Signal Processing

Toshihiko Hirooka, Associate Professor

Research Area of High Accuracy Measurements using Optical Fibers

Masato Yoshida, Associate Professor

[Research Target and Activities]

With the vast growth of Internet traffic, it has become increasingly important to realize a high-capacity and high-speed network. This laboratory aims to achieve a global ultrahigh-speed optical network by engaging in the research of ultrashort pulse and coherent transmission. This year, we successfully demonstrated a single-channel 2.56 Tbit/s transmission over 500 km using non-coherent Nyquist pulses with polarization-multiplexed DQPSK at 640 Gbaud (Fig. 1). In addition, we realized a 160 Gbaud, 64 QAM coherent Nyquist pulse transmission, in which single-channel 1.92 Tbit/s data were transmitted over 150 km with a spectral efficiency of 10.6 bit/s/Hz.

[Staff]

Distinguished Professor: Masataka Nakazawa, Dr. Associate Professor: Toshihiko Hirooka, Dr.
Associate Professor: Masato Yoshida, Dr. Assistant Professor: Keisuke Kasai, Dr.

[Profile]

Masataka Nakazawa received the Ph. D. degree from the Tokyo Institute of Technology in 1980. He joined the Ibaraki Electrical Communication Laboratory, Nippon Telegraph & Telephone Public Corporation. He was a visiting scientist at MIT in 1984-1985. In 2001, he became a Professor of the Research Institute of Electrical Communication, Tohoku University, where he has been engaged in research on ultrahigh-speed optical communication including soliton transmission, nonlinear effects in fibers, mode-locked lasers, and photonic crystal fibers.

Toshihiko Hirooka received the Ph. D. degree from Osaka University in 2000. From 2000 to 2002, he was a Research Associate at University of Colorado at Boulder. He is currently an Associate Professor at the Research Institute of Electrical Communication, Tohoku University. He has been engaged in research on ultrahigh-speed optical communications and nonlinear fiber optics.

Masato Yoshida received the Ph.D. degree from Tohoku University in 2001. In 2001, he joined the Research Institute of Electrical Communication, Tohoku University, where he is currently an Associate Professor. His research interests include mode-locked fiber lasers, coherent optical communication, and photonic crystal fibers.

[Papers]

- [1] K. Kasai, Y. Wang, S. Beppu, M. Yoshida, and M. Nakazawa, "80 Gbit/s, 256 QAM coherent transmission over 150 km with an injection-locked homodyne receiver," *Opt. Express*, vol. 23, no. 22, pp. 29174-29183, 2015
- [2] K. Harako, D. Suzuki, T. Hirooka, and M. Nakazawa, "2.56 Tbit/s/ch (640 Gbaud) polarization-multiplexed DQPSK non-coherent Nyquist pulse transmission over 525 km," *Opt. Express*, vol. 23, no. 24, pp. 30801-30806, 2015
- [3] D. O. Otuya, K. Kasai, T. Hirooka, and M. Nakazawa, "Single-channel 1.92 Tbit/s, 64 QAM coherent Nyquist orthogonal TDM transmission with a spectral efficiency of 10.6 bit/s/Hz," *J. Lightwave Technol.* vol. 34, no. 2, pp. 768-775, 2016

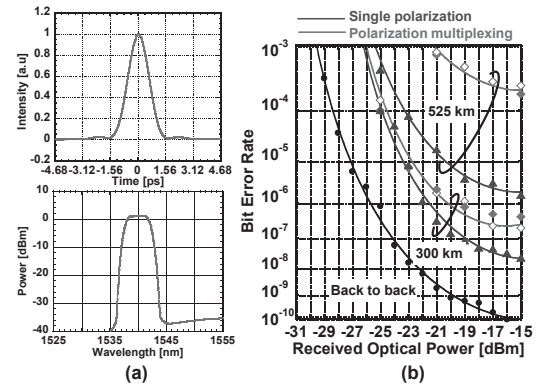

Fig. 1 2.56 Tbit/s-500 km transmission result. (a) Nyquist pulse waveform and spectrum, (b) BER characteristics.

Applied Quantum Optics

Research on Innovative Highly Functional Photonic Semiconductor Devices

Highly Functional Photonics Hiroshi Yasaka, Professor

[Research Target and Activities]

Novel functional photonic devices including high function laser diode (LD) sources are being investigated to explore new-generation photonic network systems.

The study on ultra-high-speed semiconductor laser with external cavity is being continued. It was confirmed that the frequency response characteristic of a LD can be controlled by introducing a hybrid modulation scheme where cavity loss and injection current of the laser are modulated simultaneously. The modulation scheme will contribute to the drastic bandwidth enhancement of a semiconductor laser by collaborating with the photon-photon resonance effect from external cavity.

The study on compact and narrow linewidth semiconductor laser sources is also being proceeded. It was confirmed that the phase noise of the semiconductor laser can be reduced up to some GHz by applying the optical negative feedback method we proposed.

Furthermore, the study on a flat-top optical frequency comb generation is being carried out by using a Mach-Zehnder modulator (MZM). It was confirmed that very flat (< 0.5 dB) 13-ch optical frequency comb was able to be generated by harmonic superposition of RF signals to the modulator.

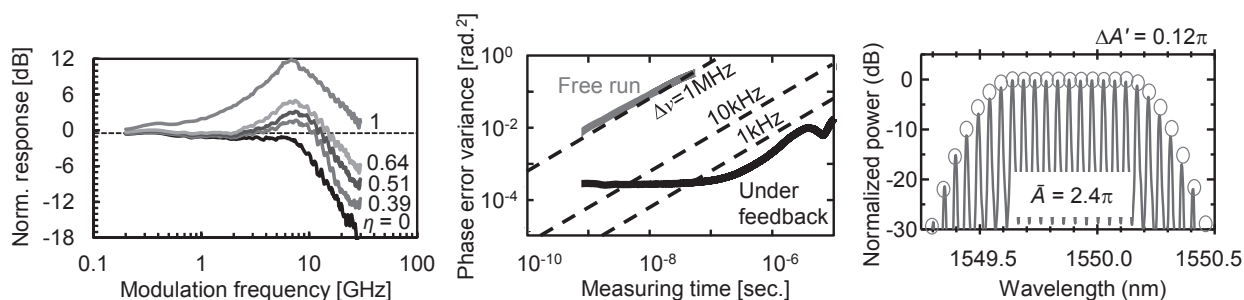

Results for hybrid modulation laser (left), compact narrow linewidth semiconductor laser (middle), and flat optical frequency comb generation using MZM (right).

[Staff]

Professor : Hiroshi Yasaka, Dr.
 Assistant Professor : Nobuhide Yokota, Dr.

[Profile]

Hiroshi Yasaka received M.S. degrees in physics from Kyusyu University in 1985, and Ph.D. degree in electronic engineering from Hokkaido University in 1993. In 1985 he joined Nippon Telegraph and Telephone (NTT) Corporation. Since then, he has been engaging in research and development on semiconductor photonic devices for optical fiber communication systems. From 2008 he has been a professor of Tohoku University.

[Papers]

- [1] S. Mieda, S. Shiratori, N. Yokota, W. Kobayashi, and H. Yasaka, "Intra-cavity Loss Modulation for Ultra-High-Speed Direct Modulation Lasers Based on Photon-Photon Resonance," Applied Physics Express, vol. 8, No. 8, 082701, July, 2015. - DOI:10.7567/APEX.8.082701
- [2] N. Yokota, T. Miki, K. Abe, and H. Yasaka, "Nonlinearity of Semiconductor Mach-Zehnder Modulator for Flat Optical Frequency Comb," IEEE Photonics Technology Letters, vol. 27, No. 21, pp. 2219-2221, Nov., 2015. - DOI 10.1109/LPT.2015.2457429
- [3] N. Yokota, K. Abe, S. Mieda, and H. Yasaka, "Harmonic superposition for tailored optical frequency comb generation by Mach-Zehnder modulator," Optics Letters, vol. 41, No. 5, pp. 1026-1029, Mar., 2016. - DOI 10.1364/OL.41.001026

Advanced Wireless Information Technology

For realization of the next generation mobile network

Advanced Wireless Information Technology Noriharu Suematsu, Professor
Advanced Wireless Network Technology Suguru Kameda, Associate Professor

[Research Target and Activities]

Toward the realization of a ubiquitous and broad-band wireless network, we are actively engaged in the research work on dependable and low power consumption advanced wireless IT. We cover the whole technical fields from the lower to higher layers, i.e., signal processing, RF/Mixed signal device, antenna, MODEM and network technologies.

We have developed

location-based interference control method for heterogeneous wireless networks. The virtual sector method was proposed to solve the hidden/exposed node problems. We have also developed RF-IC and modules like sample-and-hold circuit for high speed and low power wireless communication system.

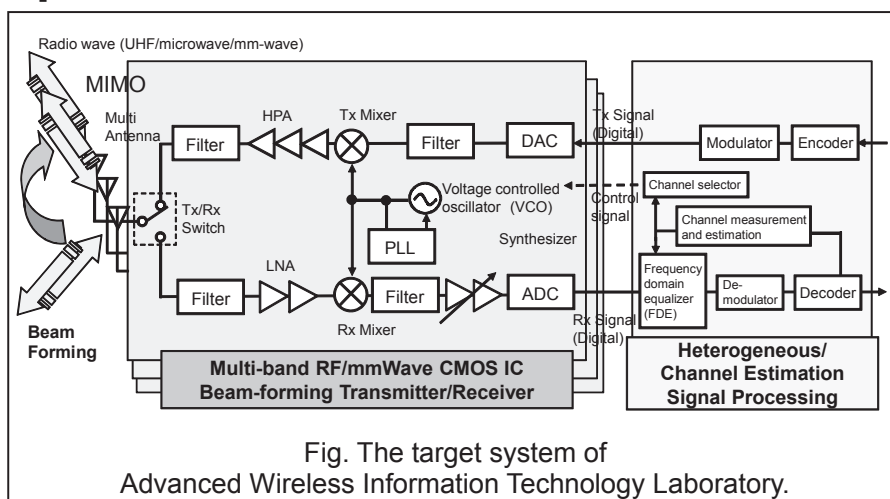

Fig. The target system of Advanced Wireless Information Technology Laboratory.

[Staff]

Professor: Noriharu Suematsu, Ph. D
 Associate Professor: Suguru Kameda, Ph. D
 Assistant Professor: Mizuki Motoyoshi, Ph.D

[Profile]

Noriharu Suematsu received the M.S. and Ph.D. degrees in Electronics and Communication Engineering from Waseda University in 1987 and 2000. From 1987 to 2010, he had been with the R&D center of Mitsubishi Electric, Japan. Since 2010, he has been a professor of Research Institute of Electrical Communication (RIEC), Tohoku University. He received the OHM technology award from the promotion foundation for electrical science and engineering in 2002 and Prize for Science and Technology, the Commendation for Science and Technology by the Minister of Education, Culture, Sports, Science and Technology in 2009.

Suguru Kameda received the B.S., M.S. and Ph.D. degrees in Electronics Engineering from Tohoku University in 1997, 1999 and 2001, respectively. From 2001, he was an assistant professor of the RIEC. From 2012, he has been currently an associate professor.

[Papers]

- [1] D Banda, *et al.*, "1/2fs Direct RF Under Sampling Receiver for Multi-Channel Satellite Systems," IEICE Transaction, vol.E98-C, No.7, pp.669-676, July 2015.
- [2] T. Koizumi, *et al.*, "A CMOS Series/Shunt Switching Type S/H IC for Ka-Band Direct RF Under Sampling Receive," 2015 Asia-Pacific Microwave Conference (APMC), Dec. 2015.
- [3] N. Suematsu, *et al.*, "Direct RF undersampling receiver for high-SHF band digital beam forming," MTT-S International Microwave and RF Conference (IMaRC), 2015 IEEE, pp.133-135, Dec. 2015.
- [4] N. Suematsu, *et al.*, "QZSS SS-CDMA Location and Short Message Communication System," The 18th International Symposium on Wireless Personal Multimedia Communications (WPMC'15), Dec. 2015.

Information Storage System

Research on Large Capacity Information Storage System using High Density Perpendicular Magnetic Recording

Information Storage Systems: Hiroaki Muraoka, Professor
Recording Theory Computation: Simon Greaves, Associate Professor

[Research Target and Activities]

The amount of digital information is rapidly growing year by year, which is estimated to reach to 40 Zetta-byte in 2020. High areal density magnetic recording is the key technology to store the extremely large capacity information. Next-generation perpendicular magnetic recording is explored in order to continuously develop the areal density of hard disk drives beyond the conventional density limit, i.e., a near-future target of 1 Tera-bit/inch² and ultimately exceeding 5 Tera-bit/inch². Theoretical studies including a micromagnetic computer simulation in association with an experimental approach are carried out to develop the next generation of high density perpendicular recording devices.

As we have proposed, the magnetic nano-structure of recording media is the most essential parameter to achieve high density perpendicular recording. Bit-patterned medium (Fig 1) is a promising candidate. We have revealed the possibility of an areal density of 5 Tera-bit/inch² in conjunction with heat assisted recording. We revealed that the thermal stability of the bit-patterned media is observed as the write error rate, not only the amplitude reduction of the written bits.

Research on information storage systems (Fig. 2) is being carried out. High data transfer rate by distributed file system with grouped disk drives was investigated. It was experimentally demonstrated that the data transfer rate of properly designed system was proportional to the number of drives.

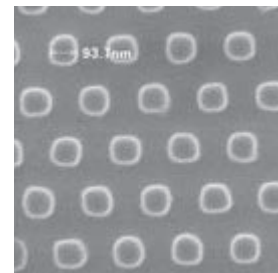

[Staff]

Professor: Hiroaki Muraoka, PhD (since 2000)
 Associate Professor: Simon Greaves, PhD (since 2003)
 Secretary: Chie Watanabe

[Profile]

Hiroaki Muraoka joined Tohoku University in 1991. Since then, he has been engaged in research on high-density magnetic recording devices, systems and recording theories, mainly for perpendicular magnetic recording. He received PhD degree in 1981. He is a Fellow of IEEE.

Simon Greaves has been at Tohoku University since 2003. He uses micromagnetic simulations at magnetic recording to investigate the potential of future storage devices. He received his Ph.D in 1993 from Salford University, UK.

[Papers]

- [1] Simon John Greaves, Yasushi Kanai, and Hiroaki Muraoka, "Microwave-Assisted Shingled Magnetic Recording," IEEE Trans. Magn., Vol. 51, No. 11, 3001204, Nov 2015.
- [2] Hiroaki Muraoka and Simon John Greaves, "Two-Track Reading With a Wide-Track Reader for Shingled Track Recording," IEEE Trans. Magn., Vol. 51, No. 11, 3002404, Nov 2015.

Ultra-broadband Signal Processing

Novel Millimeter-wave and Terahertz Integrated Electron Devices and Systems

Ultra-Broadband Devices and Systems: Taiichi OTSUJI, Professor

Ultrafast Electron Devices: Tetsuya SUEMITSU, Associate Professor

Ultra-Broadband Device Physics: Stephane BOUBANGA TOMBET, Associate Professor

[Research Target and Activities]

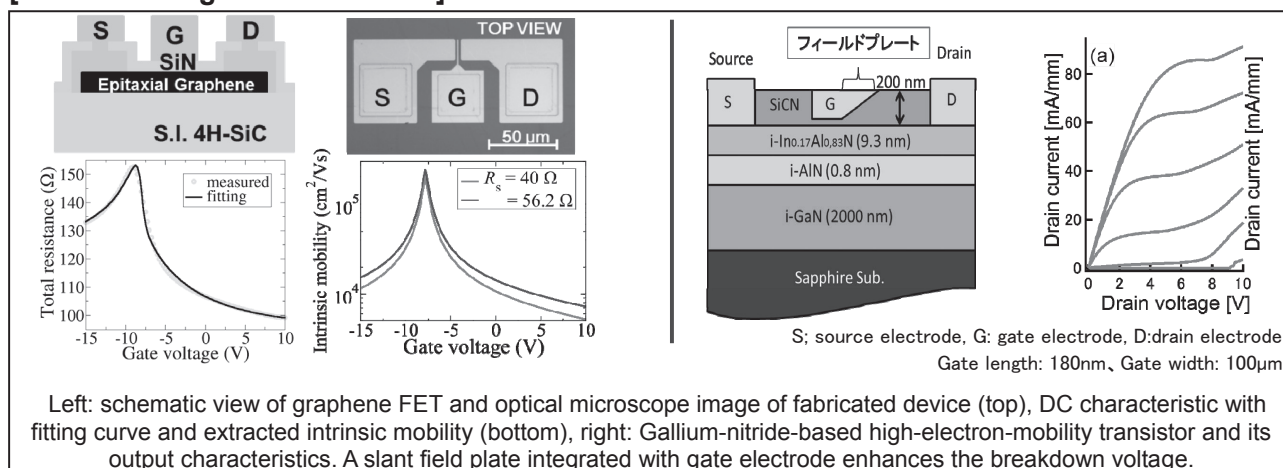

We are developing novel, integrated electron devices and circuit systems operating in the terahertz (THz) region. This fiscal year, toward creation of graphene-based terahertz lasers, we have fabricated graphene FETs with high-quality graphene channels on SiC and with SiN gate dielectrics, and we have shown carrier intrinsic mobilities of the FETs around 200,000 cm²/Vs, an order of magnitude larger than conventional data, extracted from their DC characteristics by an originally developed fitting model. Another important achievement is on microwave and millimeter-wave high-electron-mobility transistors (HEMTs) based on compound semiconductor materials such as indium-gallium arsenide (InGaAs) and gallium-nitride (GaN). Improved breakdown voltage in these HEMTs are achieved by a unique slant field plate integrated with a gate electrode.

[Staff]

Professor: Taiichi OTSUJI, Dr. Eng.

Visiting Professor: Victor RYZHII, Ph.D.

Associate Professor: Tetsuya SUEMITSU, Dr. Eng.

Associate Professor: Stephane Albon BOUBANGA TOMBET, Ph.D.

Assistant Professor: Akira SATOU, Dr. Comp. Sci.

Post-Doctoral Research Fellow: Adrian DOBROIU, Ph.D.

Post-Doctoral Research Fellow: Takayuki WATANABE, Dr. Eng.

Secretary: Kayo UENO

[Profile]

Taiichi OTSUJI: received the Dr. Eng. deg. from Tokyo Tech., Japan, in 1994. After working for NTT Labs., Japan, since 1984, he joined Kyutech in 1999, as an Assoc. Prof., being a prof. from 2002. Since 2005, he has been a Prof. at RIEC, Tohoku Univ., Japan. Recipient of the Outstanding Paper Award of the 1997 IEEE GaAs IC Symposium. Distinguished Lecturer, Electron Device Society, IEEE, since 2013. Member of IEEE (Fellow), OSA (Senior), MRS, SPIE, IEICE, and JSAP.

Tetsuya SUEMITSU: received Dr. Eng. from Waseda Univ., Japan, in 2000. Research Scientist, NTT Labs., Japan (1994- 2006); Visiting Scientist, MIT, USA (2002-2003); Assoc. Prof., Tohoku Univ., Japan (2006-). Recipient of the Best Paper Award, IEICE (2003), and the ELEX Best Paper Award, IEICE (2007). Member of IEEE(Senior), APS, JSAP, and PSJ.

Stephane BOUBANGA TOMBET: received Ph.D. from Montpellier 2 Univ., France, in 2008. JSPS Postdoctoral Research Fellow, Tohoku Univ., Japan (2009-2010); Postdoctoral Researcher, Tohoku Univ., Japan (2011); Physics Consultant, University of Rouen, France (2011); Postdoctoral Researcher, Los Alamos National Lab., USA (2012-2013). Associate Professor, Tohoku Univ., Japan (2013-present).

[Papers]

- [1] T. Otsuji, "Trends in the Research of Modern Terahertz Detectors: Plasmon Detectors," IEEE Trans. Thrz. Sci. Technol., Vol. 5, No. 6, pp. 1110-1120, 2015.
- [2] T. Suemitsu, K. Kobayashi, S. Hatakeyama, N. Yasukawa, T. Yoshida, T. Otsuji, D. Piedra, and T. Palacios, "A new process approach for slant field plates in GaN-based high-electron-mobility transistors," Jpn. J. Appl. Phys., Vol. 55, pp. 01AD02-1-6, 2015.
- [3] P. Faltermeier, P. Olbrich, W. Probst, L. Schell, T. Watanabe, S.A. Boubanga Tombet, T. Otsuji, and S.D. Ganichev, "Helicity sensitive terahertz radiation detection by dual-grating-gate high electron mobility transistors," J. Appl. Phys., Vol. 118, Iss. 8, pp. 084301-1-6, 2015.

Aims and Achievements of Human Information Systems Division

To realize advanced information communications systems, it is essential to understand and apply sophisticated information processing mechanisms of human being as well as to establish communications environments in that human can communicate anywhere, anytime without recognizing the communications tools. The aim of this division is to research and develop core and system technologies essential to advanced human friendly information and communications systems through understanding biological information generation mechanisms, human information processing mechanisms focusing on acoustic and visual inputs, and optimizing the communications environments.

To achieve the goal of the Division, three laboratories have been carrying out researches and developments in the following areas: (1) Electromagnetic Bioinformation Engineering, (2) Advanced Acoustic Information Systems, (3) Visual Cognition and Systems.

The goals and achievements in the fiscal year 2014 of each laboratory are described in detail below.

(1) Electromagnetic Bioinformation Engineering

(Aims) This laboratory aims at obtaining the high accuracy sensor system for the signals from the human body or electric devices and at obtaining the system for approaching action to the human body by using the nano-scale controlled magnetic materials and by the development of the devices under the functions of the magnetics.

(Achievements) We obtained highly sensitive strain sensor utilizing the method of inverse-magnetostriction. The sensor shows 10000 times greater sensitivity compare with the conventional strain gage. New method to obtain nano-composite materials by electro-chemical technique was found. This method realizes the high-energy thin film magnet. New mechanism to reduce the iron loss of the magnetic core materials was studied. Collaborating research with steel companies has been started. The study about the magnetic actuator was carried out for tiny pump which can set in blood tube with a manufacturer of medical equipment.

(2)Advanced Acoustic Information Systems

(Aims) To realize future high-definition communications systems with rich and natural sense of presence, this laboratory aims at developing acoustic information processing technologies based on good knowledge of human auditory system as well as multimodal perception relating to hearing.

(Achievement) We are devoting in deepening of the understanding human spatiotemporal perceptual processes of audio-vestibular information. Moreover, We also study how the sense of presence and verisimilitude are affected by physical factors involved in multimodal content consisting of auditory, visual and vestibular information. These studies are

particularly important to realize future multi-modal sensory information processing and communication systems. Moreover, we continued to develop advanced acoustic systems. These include 3D virtual auditory displays based on our accumulated knowledge of human auditory space perception, sensing and reproduction system based on High-order Ambisonics consisting of over 100 channels, and 252-ch real-time binaural spatial sound sensing technique (SENZI), which can comprehensively record 3D sound space information. They are keenly required to realize super-definition audio-visual communications in near future.

(3) Visual Cognition and Systems

(Aims) This laboratory aims at understanding the mechanisms of human visual perception in our brain to improve the design of visual information display in the information & communication technologies.

(Achievements)

Firstly, we investigated coordinated movements of eyes and head in vision for action under little restriction of body movements and the used the knowledge to improve a model of the gaze prediction in given images. Secondly, we investigated object based attention using SSVEP (steady state visual evoked potential) and found that attention spreads over within object area independently of probe presentations, which participants are asked to detect. This revealed that object attention is a static phenomenon rather than a dynamic phenomenon such as a prioritization of attention shift.

Electromagnetic Bioinformation Engineering

Communication with human body

Electromagnetic Bioinformation Engineering, Kazushi Ishiyama, Professor
 Electromagnetic Biomaterial Engineering, Shuichiro Hashi, Associate Professor

[Research Target and Activities]

We studied the mechanism of obtaining the magnetic anisotropy of the magnetic thin films for the sensitive magnetic sensors. We obtained a non-metal probe for high frequency magnetic field, and confirmed the probe can measure the high frequency magnetic field with its phase information. In addition, 3D position detecting system using magnetic markers was studied to improve its position accuracy. The study about the magnetic actuator driven by the external magnetic field was carried out for biomimetic robots using the rotational magnetic field, and small wireless pumps were obtained and clarified for their application for an artificial heart-support pump.

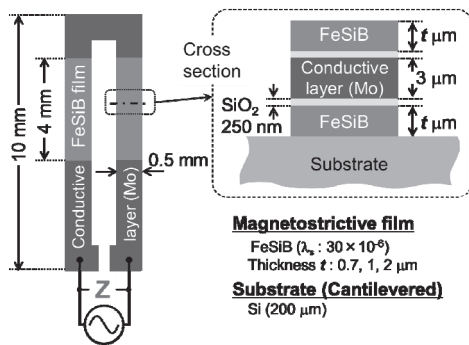

Fig. 1 Schematic diagram of high sensitive vibration sensor

[Staff]

Professor: Kazushi Ishiyama, Dr.
 Associate Professor: Shuichiro Hashi, Dr.

[Profile]

Kazushi Ishiyama received his MS and PhD degrees in Electrical Engineering from Tohoku University in 1986 and 1993, respectively. His research interests are in the area of magnetics and magnetic applications.

Shuichiro Hashi received the DE degree in Electrical Engineering from Tohoku University in 1998. His research interests are in the area of magnetic measurement and magnetic materials.

[Papers]

- [1] Y. Hayashi, S. Hashi, H. Kura, T. Yanai, T. Ogawa, K. Ishiyama, M. Nakano, H. Fukunaga, "Electrochemical fabrication of nanocomposite films containing magnetic metal nanoparticles," Japanese Journal of Applied Physics, Vol. 54, p. 075201, June (2015).
- [2] K. Iwata, M. Suzuki, M. Hashimoto, M. Ueda, Y. Matuoka, T. Yasue, T. Koshikawa, M. Kotsugi, T. Ohkochi, T. Kinoshita, Y. Watanabe, K. Ishiyama, "Temperature dependence of lancet domains in grain-oriented Fe-3%Si steels," IEEE Transactions on Magnetics, Vol. 51, No. 11, 2002504, November (2015).
- [3] J. Huang, T. Mori, K. Takashima, S. Hashi, Y. Kitamura, "IM6D: Magnetic Tracking System with 6-DOF Passive Markers for Dexterous 3D Interaction and Motion," ACM Transactions on Graphics, Vol. 34, No. 6, 217, November (2015).

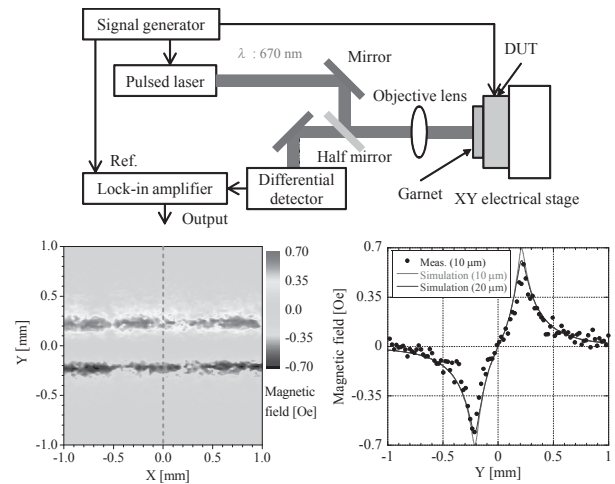

Fig. 2 High frequency magnetic field imaging system using magneto-optical crystal probe

Advanced Acoustic Information Systems

Development of next generation communication systems

Advanced Acoustic Information Systems: Yôiti Suzuki, Professor

Auditory and Multisensory Information Systems: Shuichi Sakamoto, Associate Professor

[Research Target and Activities]

The main interest of this laboratory is the study of information processing by the human auditory system. At the same time, we aim to realize a 'comfortable' sound environment by exploiting digital signal processing techniques. One example is the development of three-dimensional auditory displays, which present sound images by simulating the transfer functions for the sound paths from the sound sources to the listeners' external ears. Another example is the proposal of 3D sound field information sensing systems. These systems are expected to convey a high-quality virtual sound space, which is keenly sought for multimedia communications, cyberspace systems and virtual reality systems. Moreover, in 2015, we put a lot of effort to develop systems to acquire 3D sound-space information capable of saving, transmitting, and reproducing accurate sound-space information at a distant place. In regards to three-dimensional sound space information recording using microphone arrays, we realized a real-time system using a spherical microphone array and FPGAs. From a psychoacoustical point of view, we also investigated the effect of self-motion, including head rotation, on the auditory space perception.

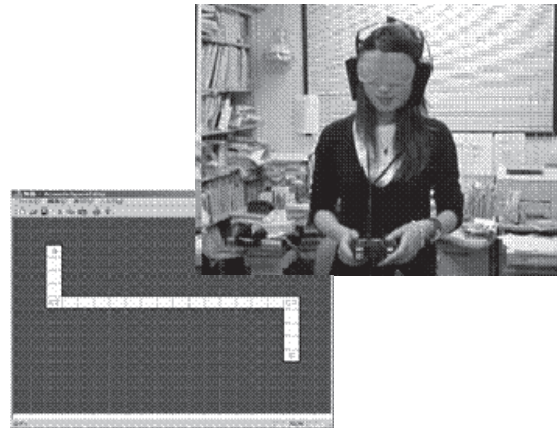

Fig. 1 Application for the training of spatial cognition using a high-definition virtual auditory display

[Staff]

Professor: Yôiti Suzuki, Dr., Associate Professor: Shuichi Sakamoto, Dr.,

Assistant Professor: Zheng Lie Cui, Dr., Jorge Treviño, Dr.,

Technical Staff: Fumitaka Saito

[Profile]

Yôiti Suzuki graduated from Tohoku University in 1976 and received his Ph. D. degree in electrical and communication engineering in 1981. His research interests include psychoacoustics and digital signal processing of acoustic signals. He served as president of the Acoustical Society of Japan from '05 to '07. He is a fellow of the Acoustical Society of America.

Shuichi Sakamoto graduated from Tohoku University in 1997 and received his Ph. D. degree in electrical and communication engineering in 2004. His research interests include human auditory and multisensory information processing and development of advanced multimodal information systems.

[Papers]

- [1] S. Sakamoto, S. Hongo, T. Okamoto, Y. Iwaya and Y. Suzuki, "Sound-space recording and binaural presentation system based on a 252ch microphone array," *Acoustical Science and Technology*, 36(6), 516-526 (2015).
- [2] T. Shimizu, J. Trevino, S. Sakamoto and Y. Suzuki, "A multi-zone approach to sound field reproduction based on spherical harmonic analysis," *Acoustical Science and Technology*, 36(5), 441-444 (2015).
- [3] A. Honda, T. Kanda, H. Shibata, S. Sakamoto, Y. Iwaya, J. Gyoba and Y. Suzuki, "Senses of presence and verisimilitude of audio-visual contents: Effects of sounds and playback speeds on sports video," *Interdisciplinary Information Sciences Journal*, 21(2), 143-149 (2015).

Visual Cognition and Systems Laboratory

Understanding human visual system for the better communication with visual information

Visual Cognition and Systems Satoshi SHIOIRI, Professor
 Cognitive Brain Functions Ichiro KURIKI, Associate Professor

[Research Target and Activities]

Our target is to understand the vision-related brain functions in order to apply the knowledge to realize human oriented information communication systems. We made achievements in the fields of visual attention, depth perception and color perception.

Firstly, we investigated coordinated movements between eyes and head in relation to visual cognitive processing. We found that patterns of eye-head coordination differed those observed in single gaze shift studies, and that the distribution peak of eye position was biased in the same direction as head direction. Secondly, we proposed a gaze prediction method based on head direction. We used a probability distribution of eye position based on head direction and added this information to a model of saliency-based visual attention. Our model improved the accuracy of gaze prediction. Thirdly, we investigated the neural mechanisms of object-based attention by using steady-state visual evoked potentials.

[Staff]

Professor : Satoshi Shioiri, Ph.D.
 Associate Professor : Ichiro Kuriki, Ph.D.

[Profile]

Satoshi SHIOIRI Professor Shioiri graduated Tokyo Institute of Technology and received Dr. Eng in 1986. Then, he was a postdoctoral researcher at University of Montreal until May of 1989. From June of 1989 to April of 1990, he was a research fellow at Auditory and Visual Perception Laboratories of Advanced

Telecommunications Research Institute. He moved to Chiba University at May of 1990, where he spent 15 years as an assistant professor, an associate professor, and a professor of Department of Image Sciences Department of Image, Information Sciences and Department of Medical Systems. In 2005, he moved to Tohoku University. Since then, he has been a professor of Research Institute of Electrical Communication of Tohoku University.

Ichiro KURIKI Dr. Kuriki received Ph.D. degree from Tokyo Institute of Technology in 1996. After then, he worked at Imaging Science and Engineering Laboratory, Tokyo Institute of Technology as a research associate until October, 1999. He worked as a research associate at the Department of Mathematical Engineering and Information Physics, Graduate School of Engineering, the University of Tokyo until March, 2001. He worked as a researcher in Communication Science Laboratories of NTT Corporation until December, 2005. He joined the Research Institute of Electrical Communication, Tohoku University as an Associate Professor in January, 2006.

[Papers]

1. Fang Y, Nakashima R, Matsumiya K, Kuriki I, Shioiri S: Eye-head coordination for visual cognitive processing. PLoS ONE 10(3): e0121035. doi:10.1371/journal.pone.0121035, 2015.
2. Nakashima R, Fang Y, Hatori Y, Hiratani A, Matsumiya K, Kuriki I, Shioiri S: Saliency-based gaze prediction based on head direction. Vision Research 117, 59-66, 2015.
3. Kuriki I, Omori N, Kashiwase Y, Matsumiya K, Tokunaga R, Shioiri S: Measurement of object-based attention using steady-state visual evoked potentials. Japanese Journal of Physiological Psychology and Psychophysiology (in press)

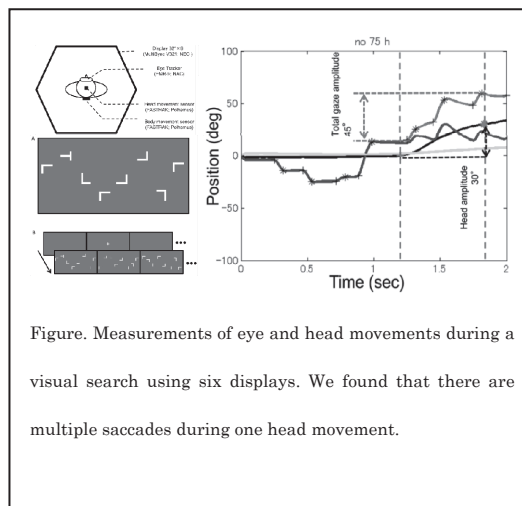

Figure. Measurements of eye and head movements during a visual search using six displays. We found that there are multiple saccades during one head movement.

Research Targets and Activities of Systems & Software Division

The goal of System & Software Division is to realize Ubiquitous environment. In an ideal ubiquitous environment, everyone can communicate with anybody, anywhere, with any kind of information, at any time, freely and in real time. Our division has the following five research fields related to such high-level system, software and content by integrating computer and communication:

- Software Construction: Reliable and high-level software.
- Computing Information Theory: Fundamental theory of new software.
- Communication Network: Symbiotic computing.
- Information Content: Technologies for interactive content.
- Structure of Information Society (Visitor Section).

An overview of research results from Apr. 2013 to Mar. 2014 of these fields except the visitor section is described in this section.

(1) Software Construction

We have been researching on theoretical foundations for flexible and reliable programming languages, and have been developing SML#, a new programming language in the ML family embodying our research results. The major results of the 2015 academic year include the following. (1) We have developed a type theory and compilation method for high-level and type-safe access to key-value stores and have showed that an ML-style programming language can be extended to high-level and type-safe key-value stores. (2) Development of the SML# compiler includes the following. (i) We have developed and implemented a fully concurrent garbage collection algorithm. (ii) Based on the concurrent GC, we have developed 64 bit native-thread support.

(2) Computing Information Theory

Rewriting systems are mathematical formalisms which can offer both flexible computing and effective reasoning with equations. Our research focuses on theoretical features of rewriting systems and applications to automated theorem proving, algebraic specifications, and functional and logic programming languages. The main results of this year are as follows. (i) We propose context-moving and context-splitting transformations for term rewriting systems, and develop a new automated theorem proving system which incorporates these transformations into rewriting induction. (ii) We continued to develop an automated confluence prover ACP for term rewriting systems based on various proof techniques. In the 4th confluence competition (CoCo 2015), ACP has won first place.

(3) Communication Network Systems

In this year, we have done the following studies. (a) Application of Active Information Resources: A concept of AIR-based personal knowledge base system is proposed and an AIR-based memory recall function was developed to support various human creative activities.

(b) Personalization of Secure Service: A personalization method of user-oriented secure services was proposed using agent-based sandbox mechanism. The effectiveness of the proposed mechanism was demonstrated by experiments. (c) Agent-based Internet of Things (AIoT) framework: A new concept of AIoT was proposed based agent/multiagent technologies. A cooperation method based on plan knowledge and the adaptive control functions for AIoT had been developed and verified using experiment systems.

(4) Information Content

We are conducting comprehensive research on a variety of technologies related to interactive content which creates new value through interactions with humans. This year we firstly proposed a novel magnetic 3D tracking system for dexterous 3D interactions. Secondly, we explored a series of interactive robotic displays such as TransformTable, MovementTable and Shape-shifting wall display which dynamically affect and guide user's physical workspace according to varying contexts. Thirdly, we established a model of Anshin as a concept of subjective well-being between humans and robots.

Software Construction Laboratory

Foundations for Developing High-level and Reliable Programming Languages

Software Construction Atsushi Ohori, Professor

[Research Target and Activities]

Today's software systems are becoming more and more complicated due to the need of integrating various computation resources available in the Internet. A key to control the complexity and to enhance the reliability of such a system is to develop a high-level programming language that can directly represent various resources and automatically detect potential inconsistencies among the components in a system. Based on this general observation, our research aims at establishing both firm theoretical basis and implementation method for flexible yet reliable programming languages for advanced applications. Research topics on theoretical foundations include:

logical foundations for compilation, verification of low-level code, and type-directed compilation for polymorphic languages. We are also developing a new practical ML-style programming language, SML#, which embodies some of our recent results such as record polymorphism, rank-1 polymorphism, and high-degree of inter-operability with existing languages and databases.

The major results of the 2015 academic year include the following. (1) Developments in theoretical foundations: we have developed a type theory and compilation method that allow us to seamlessly integrate JSON data in a typed polymorphic programming language, and have implemented in SML# compiler. The result is to appear in Proceedings of ECOOP 2016 (See [3] below). (2) Development of the SML# compiler. We have developed an algorithm and implementation techniques for a fully concurrent garbage collection method, and have implemented it in the SML# compiler. This result enables us to support native threads on multicore CPUs.

[Staff]

Professor : Atsushi Ohori, Dr.

Assistant Professor : Katsuhiko Ueno, Dr.

[Profile]

Atsushi Ohori. Professor Atsushi Ohori was born in 1957. He received his BA degree in Philosophy from University of Tokyo, 1981; received his MSE degree in Computer and Information Science from University of Pennsylvania, 1986; and received his Ph.D. degree in Computer and Information Science from University of Pennsylvania, 1989. He worked for Oki Electric Industry as a programmer, a researcher and a senior researcher from 1981 until 1993. From 1989 until 1990, he spent one year in University of Glasgow as a postdoctoral research fellow funded by Royal Society Research Fellowship. In 1993, he joined Research Institute for Mathematical Sciences, Kyoto University as an Associate Professor. In 2000, he joined Japan Advanced Institute of Science and Technology as a Professor. In 2005, he moved to RIEC, Tohoku University as a Professor.

[Papers]

- [1] Katsuhiko Ueno, Atsushi Ohori. A Type Safe Access to Key-value Stores from Functional Languages. *Journal of Information Processing*, Vol. 24, No. 1, pp.141-151, 2016.
- [2] Katsuhiko Ueno, Atsushi Ohori: A foreign language interface from ML to shell. *New Generation Computing*, to appear.
- [3] Atsushi Ohori, Katsuhiko Ueno, Tomohiro Sasaki, Daisuke Kikuchi: A Calculus with Partially Dynamic Records for Typeful Manipulation of JSON Objects. In *Proceedings of the 30th European Conference on Object Oriented Programming (ECOOP 2016)*, 24 pages, to appear.

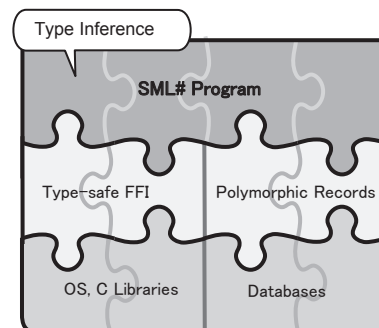

SML#: a high-level and reliable language

Computing Information Theory

Towards a New Software Paradigm Arising from Computation and Proof

Computing Information Theory Yoshihito TOYAMA, Professor

[Research Target and Activities]

We are working on the development of a new software paradigm that arises from computation and proof. For this, we focus on a rewriting formalism which offers both flexible and effective reasoning with equations. In the rewriting formalism, proofs by equational reasoning and computations by rewriting systems can be combined in a unified framework (see the figure above). We aim at applying our new paradigm to the development of formal techniques for construction and verification of reliable software. We are currently working on rewriting theories for termination, confluence, program transformation, and program verification. Recent research activities include higher-order rewriting systems, automated inductive theorem proving, combination of functional-logic languages and automated theorem proving systems.

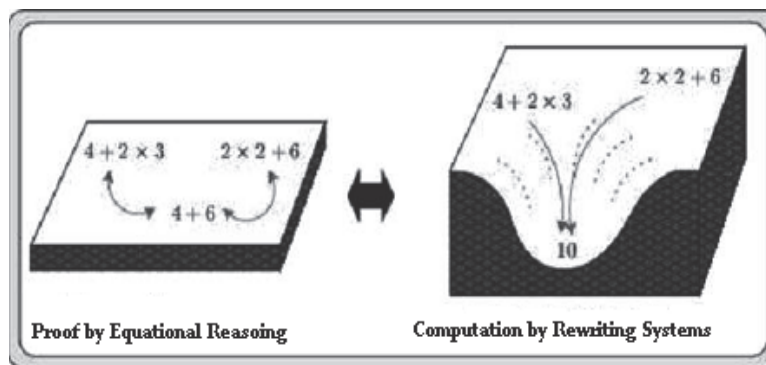

[Staff]

Professor : Toyama, Yoshihito Dr

Assistant Professor : Kikuchi, Kentaro Dr

[Profile]

Professor TOYAMA Yoshihito Toyama was born in 1952. He received his B.E. from Niigata University in 1975, and his M.E. and D.E. from Tohoku University in 1977 and 1990. He worked as a Research Scientist at NTT Laboratories from 1977 to 1993, and as a Professor at the Japan Advanced Institute of Science and Technology (JAIST) from 1993 to 2000. Since April 2000, he has been a professor at the Research Institute of Electrical Communication (RIEC) of Tohoku University. His research interests includes term rewriting systems, program theory, and automated theorem proving.

[Papers]

[1] Takaki Suzuki, Kentaro Kikuchi, Takahito Aoto and Yoshihito Toyama, Critical pair analysis in nominal rewriting, *EPiC Series in Computing*, Vol. 39, pp. 156-168, 2016.

[2] Koichi Sato, Kentaro Kikuchi, Takahito Aoto and Yoshihito Toyama, Correctness of context-moving transformations for term rewriting systems, *Lecture Notes in Computer Science*, Vol. 9527, pp. 331-345, 2015.

[3] Takaki Suzuki, Kentaro Kikuchi, Takahito Aoto and Yoshihito Toyama, Confluence of orthogonal nominal rewriting systems revisited, *Leibniz International Proceedings in Informatics*, Vol. 36, pp. 301-317, 2015.

Communication Network Systems

Support for Cooperation and Communication between Human and Systems

Intelligent Communication: Tetsuo Kinoshita, Professor

Intelligent Network: Gen Kitagata, Associate Professor

[Research Target and Activities]

In this year, the following studies had been done. (a) Application of Active Information Resources: An AIR-based memory recall function was developed to support various human creative activities. (b) Personalization of Secure Service: A personalization method of secure services using agent-based sandbox mechanism was proposed and its effectiveness was also demonstrated by experiments. (c) Agent-based Internet of Things (AIoT) framework: A cooperation method based on plan knowledge and the adaptive control functions had been developed and verified using prototype systems.

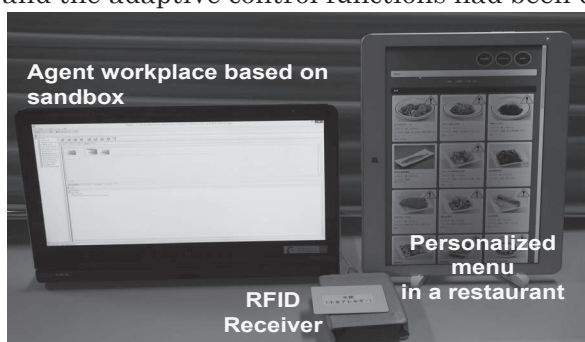

The menu is automatically customized considering allergies without exposing any sensitive information.

Secure personalized system using mobile agent

[Staff]

Professor : Tetsuo Kinoshita, Dr.

Associate Professor : Gen Kitagata, Dr.

Assistant Professor : Hideyuki Takahashi, Dr.

Assistant Professor : Kazuto Sasai, Dr.

[Profile]

Tetsuo Kinoshita received his B.E. degree in electronic engineering from Ibaraki University, Japan, in 1977, and M.E. and Dr.Eng. degrees in information engineering from Tohoku University, Japan, in 1979 and 1993, respectively. He received the IPSJ Research Award, the IPSJ Best Paper Award and the IEICE Achievement Award in 1989, 1997 and 2001. Dr. Kinoshita is a member of IEEE (SM), ACM, AAAI, IEICE (Fellow), IPSJ (Fellow) and JSAI.

Gen Kitagata is an associate professor of the Research Institute of Electrical Communication of Tohoku University, Japan. He received a doctoral degree from the Graduate School of Information Sciences, Tohoku University in 2002. His research interests include agent-based computing, network middleware design, and symbiotic computing. He is a member of IEICE and IPSJ.

[Papers]

- [1] T. Kinoshita, "Basic Characteristics of a Macroscopic Measure for Detecting Abnormal Changes in a Multiagent System," *Sensors*, Vol. 15, No. 4, pp.9112-9135, Apr. 2015.
- [2] K. Kalegele, K. Sasai, H. Takahashi, G. Kitagata, T. Kinoshita, "Four Decades of Data Mining in Network and Systems Management," *IEEE Transactions on Knowledge and Data Engineering*, Vol.27, No.10, pp.2700-2716, Oct. 2015.
- [3] K. Sasai, Y.-P. Gunji, T. Kinoshita, "Extremely Local Interaction in the Market Model," *Proc. of The Twenty-First International Symposium on Artificial Life and Robotics 2016*, pp.625-630, Jan. 2016.

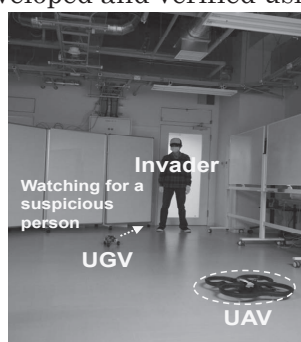

(a) UGV moves closer to the invader.

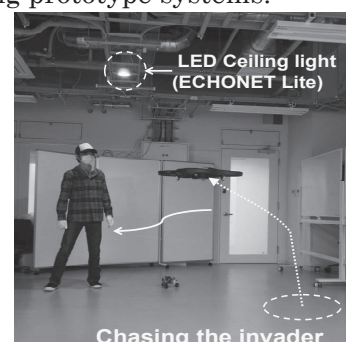

(b) UAV takes off and chases the invader.

Home security system using AIoT devices

Information Content

Technologies for Interactive Content

Interactive Content Design Yoshifumi KITAMURA, Professor

[Research Target and Activities]

Good media content has the power to enrich our lives. The effectiveness of content delivery is becoming more and more important in a wide variety of fields, such as industry, education, culture, entertainment, and so on. Expectations of its use in the general public are also increasing. We focus on non-traditional contents other than movies, music and games, conducting comprehensive research on a variety of interactive content which creates new value through interactions with humans. This year we firstly proposed a novel magnetic 3D tracking system for dexterous 3D interactions. Secondly, we explored a series of interactive robotic displays such as TransformTable, MovementTable and Shape-shifting wall display which dynamically affect and guide user's physical workspace according to varying contexts. Thirdly, we established a model of Anshin as a concept of subjective well-being between humans and robots.

[Staff]



A novel magnetic 3D tracking system (left), Robotic displays (center), Modeling robot behaviors (right)

Professor: Yoshifumi Kitamura, Dr.
 Assistant Professor: Kazuki Takashima, Dr.
 Assistant Professor: Hiroko Kamide, Dr.

[Profile]

Yoshifumi KITAMURA received B.Sc., M.Sc. and PhD. degrees in Engineering from Osaka University in 1985, 1987 and 1996, respectively. From 1987 to 1992, he was at the Information Systems Research Center of Canon Inc. From 1992 to 1996, he was a researcher at the ATR Communication Systems Research Laboratories. From 1997 to 2002, he was an Associate Professor at the Graduate School of Engineering and Graduate School of Information Science and Technology, Osaka University. Since April 2010, he has been a Professor at the Research Institute of Electrical Communication, Tohoku University. He is a fellow of the Virtual Reality Society of Japan.

[Papers]

- [1] Jiawei Huang, Tsuyoshi Mori, Kazuki Takashima, Shuichiro Hashi, and Yoshifumi Kitamura, IM6D: magnetic tracking system with 6-DOF passive markers for dexterous 3D interaction and motion, ACM Transactions on Graphics (TOG) - Proceedings of ACM SIGGRAPH Asia 2015, Volume 34, Issue 6, pp. 217:1-217:10, November 2015.
- [2] Kazuki Takashima, Yusuke Asari, Hitomi Yokoyama, Ehud Sharlin, and Yoshifumi Kitamura, MovemenTable: The Design of Moving Interactive Tabletops, In Proceedings of Human-Computer Interaction - INTERACT 2015, pp. 296-314, September 2015.
- [3] Hiroko Kamide, Koji Kawabe, Satoshi Shigemi, and Tatsyi Arai, Anshin as a concept of subjective well-being between humans and robots in Japan, Advanced Robotics, Vol. 29, Issue 24, PP. 1624-1636, November 2015.

Laboratory for Nanoelectronics and Spintronics

The Laboratory for Nanoelectronics and Spintronics of the Research Institute of Electrical Communication was established on April of 2004. Its purpose is to develop and establish the science and technology of nanoelectronics and spintronics for information technology. Utilizing the facilities installed in the Nanoelectronics-and-Spintronics building and under collaboration between the RIEC and electro-related laboratories of the Graduate Schools of Engineering, Information Sciences, Biomedical Engineering, Tohoku University, R&D of nanotechnologies of materials and devices in Nanoelectronics and Spintronics will be continued extensively. Furthermore, nation-wide and world-wide collaboration research projects will be conducted to build a systematic database in the electrical communication research area.

The Laboratory for Nanoelectronics and Spintronics mainly consists of research groups which promote following sections: Nano-Integration Devices and Processing, Semiconductor Spintronics and Nano-Molecular Devices; together with the group of Ultra-Broadband Signal Processing. These groups cooperatively carry out the research aimed at establishing a world-wide COE in the research area of nanoelectronics and spintronics.

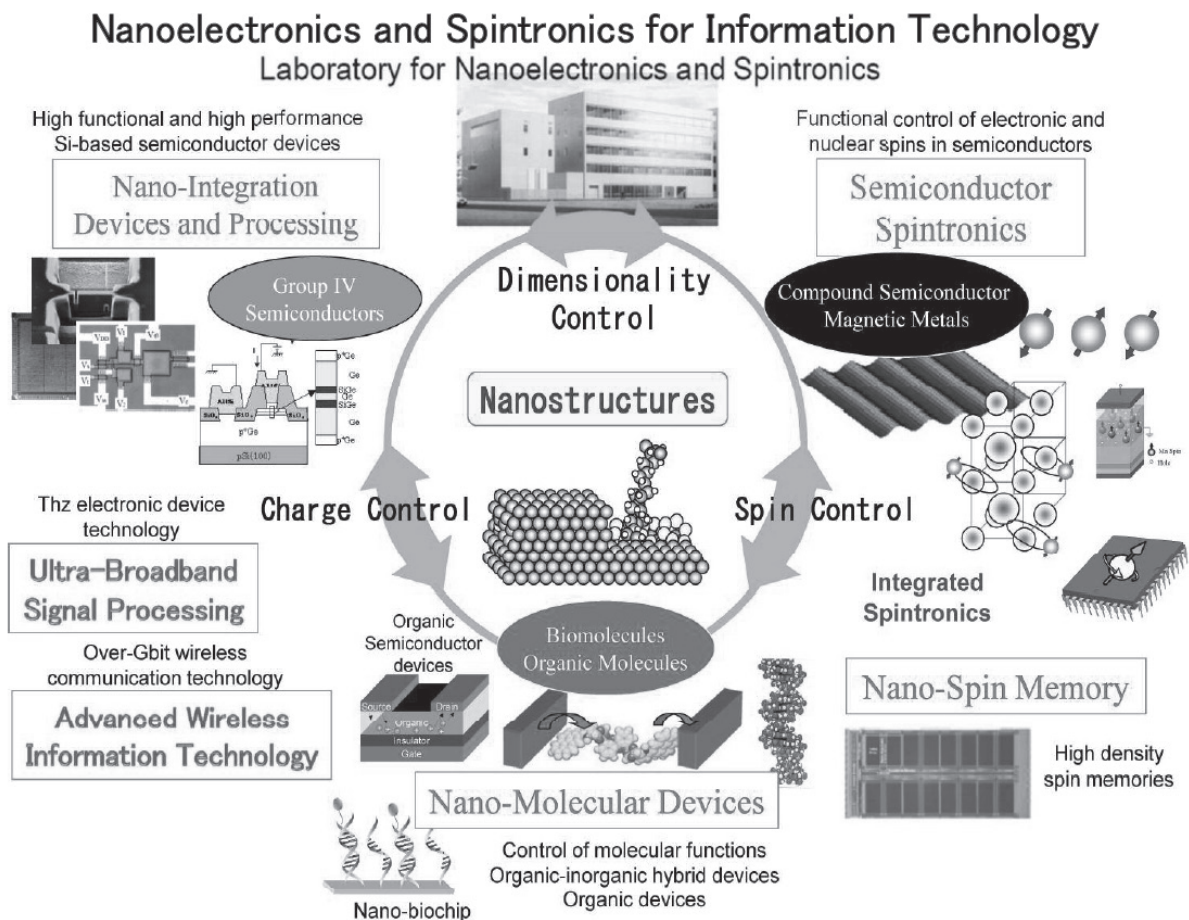

Highlights of Research Activities in 2015

Nano Integration

● Nano-Integration Devices and Processing (S. Sato and M. Sakuraba)

(1) Toward the development of computation algorithms utilizing quantum parallelism, we have introduced a quantum version of Hebb learning, by which qubit interaction is enhanced in proportion to correlation between qubits, to neuromorphic quantum computation inspired by the computational method realized with artificial neural networks. We have simulated the proposed learning method and confirmed its effectiveness successfully.

(2) Electrical Properties of Si/strained SiGe alloy/Si(100) heterostructures grown by low-energy ECR plasma CVD without substrate heating have been studied. With strain relaxation in SiGe alloy, alternation of valence band structure and clear infrared photoluminescence were observed.

(3) Toward a spatial perception system by using motion-stereo vision, we implemented a neural network model into an LSI; an orientation and time-to-contact of a planar surface are detected by integrating local image motions. The enormous neural connections are realized by using virtual connection scheme with connection tables stored in local memories and packet-based communication. We confirmed by using HDL simulation that the operation speed of the designed LSI is comparable with a C++ program performed on a common desktop CPU, while its power consumption is smaller than the that of the CPU by less than 1%.

Semiconductor Spintronics and Information Technology

● Semiconductor Spintronics (H. Ohno and S. Fukami)

Our research activities focus on realizing low-power functional spintronic devices. The outcomes in the last fiscal year are as follows: (1) Determination of spin mixing conductance at metal/semiconductor interfaces from electrical signals induced by inverse spin Hall effect under the ferromagnetic resonance in a (Ga,Mn)As/Pt structure. (2) Demonstration of electrical control of damping constant and clarification of the physical origin of magnetic damping using a ferromagnetic semiconductor (Ga,Mn)As. (3) Quantification of modulation amplitude of magnetic anisotropy induced by electric field from a nonlinear ferromagnetic resonance with a large precessional angle in nano-scale CoFeB-MgO magnetic tunnel junction devices. (4) Clarification of the mechanism that determines the universality class for a creep motion of a domain wall in ferromagnetic systems. (5) Systematic evaluation of temperature dependence of in-plane magnetic anisotropy, anisotropic magnetoresistance, and planer Hall effect in (Ga,Mn)As codoped with Li.

In addition, the following outcomes have been obtained through cooperative researches under national projects.

1. Research activities in "Research and Development of Spintronics Material and Device Science and Technology for a Disaster-Resistant Safe and Secure Society" Program under Research and Development Project for ICT Key Technology to Realize Future Societies by

MEXT: (1) Evaluation of width dependence of thermal stability of domain wall in ferromagnetic Co/Ni nanowires and clarification of the mechanism that governs the thermal stability factor of domain walls. (2) Evaluation of dot size dependence of threshold current density for spin-orbit torque induced magnetization switching in nanoscale Ta/CoFeB/MgO dots and clarification of factors that determine the threshold current density. (3) Demonstration of field-free spin-orbit torque induced magnetization switching in an antiferromagnet/ferromagnet bilayer system and observation of analogue-like response, which is suitable for applications to artificial intelligences.

2. Research activities in "Achieving Ultimate Green IT Devices with Long Usage Times without Charging" Program under Impulsing Paradigm Change through Disruptive Technologies Program of CSTI: (1) Observation of different temperature dependences of energy barrier in CoFeB-MgO magnetic tunnel junctions depending on their sizes, which can be explained by a difference in the magnetization reversal mode. (2) Evaluation of thickness dependence of damping constant for single-interface and double-interface CoFeB-MgO structures from a ferromagnetic resonance using a vector network analyzer. (3) Demonstration of the third scheme of spin-orbit torque induced magnetization switching that is useful to investigate the physical mechanism of the switching.

● **Ultra-Broadband Signal Processing (T. Otsuji, T. Suemitsu, and S. Boubanga-Tombet)**

1. Ultra-Broadband Devices and Systems

We are developing novel, integrated electron devices and circuit systems operating in the millimeter-wave and terahertz regions. III-V- and graphene-based active plasmonic heterostructures for creating new types of terahertz lasers and ultrafast transistors are major concerns. By making full use of these world-leading device/circuit technologies, we are exploring future ultra-broadband wireless communication systems as well as spectroscopic/imaging systems for safety and security.

2. Ultrafast Electron Devices

We are focusing on two important material systems for high-speed and high-frequency devices: the indium gallium arsenide (InGaAs) for ultimately high-frequency operation including sub-millimeter-wave regime, the gallium nitride (GaN) for high-power millimeter-wave applications. Our activities include the design, process, and characterization of these devices and their integrated circuits.

3. Ultra-Broadband Device Physics

We theoretically and experimentally investigate the physics of plasmonics in III-V semiconductor- and graphene-based heterostructure material systems and their device applications. Our main goal is to develop new and original plasmonic integrated devices operating in the millimeter-wave and terahertz regions for the next generation of imaging, spectroscopy, and ultra-broadband communication systems.

Nano-Molecular Devices

● Nano-Molecular Devices (M. Niwano)

1. Development of perovskite solar cells: We have investigated annealing-induced chemical and structural changes of tri-iodide (TI) and mixed-halide (MH) organometal perovskite layers using infrared absorption spectroscopy, scanning electron microscopy and x-ray diffraction measurements. We suggested that the difference in composition and structure leads to different charge transporting properties of the perovskite layers. (J. Mater. Chem. A, 3, 14195 (2015))
2. Fabrication and characterization of p+i-p+ type organic thin film transistors: Organic thin film transistors (OTFTs) have been explored because of their advantageous features such as light-weight, flexible, and large-area. We have fabricated p+i-p+ type of OTFTs in which an intrinsic (i) regioregular poly (3-hexylthiophene) (P3HT) layer is used as the active layer and highly doped p-type (p+) P3HT is used as the source and drain electrodes. We demonstrated that the fabricated p+i-p+ OTFTs work with carrier injection through a built-in potential at p/i interfaces. We found that the p+i-p+ OTFTs exhibit better FET characteristics than the conventional P3HT-OTFT with metal (Au) electrodes. (J. Appl. Phys. 119, 154503 (2016); Jpn. J. Appl. Phys., 54, 091602 (2015))
3. Investigation of neuronal extracellular recordings: Electrical signals of neuronal cells can be recorded non-invasively and with a high degree of temporal resolution using multielectrode arrays (MEAs). However, signals that are recorded with these devices are small, usually 0.01%–0.1% of intracellular recordings. We showed that the amplitude of neuronal signals recorded with MEA devices can be amplified by covering neuronal networks with an electrically resistive sheet. This technique feasibly amplifies signals of MEA recordings. (Appl. Phys. Lett., 108, 023701 (2016))

Nano-Integration Devices and Processing

Nano-integration beyond the existing technology

Nano-Integration Devices

Shigeo Sato, Professor

Group IV Quantum Heterointegration

Masao Sakuraba, Associate Professor

[Research Target and Activities]

In addition to the conventional demands such as faster operation and larger throughput, low power operation for low-carbon emission and robust operation not damaged even in a disaster are required for the development of the next generation information technology. To meet these demands, studies on high functional and high performance Si-based semiconductor devices realized by 3-D nano-processing and large scale integration of such devices are important research subjects. We study the subjects such as new transistors and memories using new materials, new devices based on new principles like quantum effects, and required 3-D processing. Moreover, we develop advanced technologies related to 3-D nano-integration, dependable mixed signal LSI, and non von Neumann architecture.

In this year, following experimental results have been obtained: 1) We have introduced a quantum version of Hebb learning to neuromorphic quantum computation inspired by the computational method realized with artificial neural networks. (2) Electrical Properties of Si/strained SiGe alloy/Si(100) heterostructures grown by low-energy ECR plasma CVD without substrate heating have been studied. With strain relaxation in SiGe alloy, alternation of valence band structure and clear infrared photoluminescence were observed.

[Staff]

Professor : Shigeo Sato, Dr.
 Associate Professor : Masao Sakuraba, Dr.
 Assistant Professor: Hisanao Akima, Dr.

[Profile]

Shigeo Sato was received his B.E. and Ph.D. degrees from Tohoku University, in 1989 and 1994, respectively. In 1996, he joined the Research Institute of Electrical Communication, Tohoku University. Now, he studies brain computer and quantum computer as a professor.

Masao Sakuraba received his B.E. and Ph.D. degrees from Tohoku University in 1990 and 1995, respectively. In 1995, he joined the Research Institute of Electrical Communication, Tohoku University. Now, he studies group IV quantum heterointegration as an associate professor.

[Papers]

[1] A. A. ShklyaeV, V. I. Vdovin, V. A. Volodin, D. V. Gulyaev, A. S. Kozhukhov, M. Sakuraba and J. Murota, "Structure and optical properties of Si and SiGe layers grown on SiO₂ by chemical vapor deposition", Thin Solid Films, vol. 579, pp. 131-135, 2015.
 [2] W. Li, S. Sato, H. Akima, M. Sakuraba, "Hydrogen Atom Desorption Induced by Electron Bombardment on Si Surface," ECS Trans., vol. 69, no. 31, pp. 35-38, 2015.
 [3] Y. Yamamoto, N. Ueno, M. Sakuraba, J. Murota, A. Mai and B. Tillack, "C and Si delta doping in Ge by CH₃SiH₃ using reduced pressure chemical vapor deposition", Thin Solid Films, vol. 602, pp. 24-28, 2016.

Towards the Realization of a Prototype Brain Computer

For implementation of a brain computer usable in a real world, developments of related techniques such as processing, device fabrication, circuit design, and architecture are necessary. In this laboratory, we study mainly on nano-integration devices and process, and make progress in the research and development of a brain computer.

The diagram illustrates the transition from traditional von Neumann Architecture to a brain-inspired architecture. On the left, the von Neumann Architecture is shown as a block diagram with Memory, Control Unit, Arithmetic Logic Unit, and Accumulator, connected to Input and Output. On the right, the Hierarchical Structure and Functional Localization of Human Brain is depicted with a brain diagram and labels for various regions like Cerebral Cortex, Hippocampus, and Amygdala. To the right of the brain diagram are two rows of images: the top row shows five vertical bars of varying heights, and the bottom row shows five 'A' characters. Below these images is a photograph of a neurochip. The caption below the diagram reads: 'Towards the Realization of a Prototype Brain Computer'.

Semiconductor Spintronics

Advanced technology for spintronics-based devices

Functional Spintronics: Hideo Ohno, Professor

Nano-Spin Materials and Devices: Shunsuke Fukami, Associate Professor

[Research Target and Activities]

We aim to deepen the understanding of spin-related physics and to develop new functional materials and devices in which electron and its spin states are controlled. We are also working on research and development of advanced technology for spintronics-based devices and integrated circuits, which offers high-performance and low-power information and communication technologies.

The outcomes in the last fiscal year include (1) demonstration of electrical control of damping constant and clarification of the physical origin of magnetic damping using a ferromagnetic semiconductor (Ga,Mn)As, (2) Clarification of the mechanism that determines the universality class for a creep motion of a domain wall in ferromagnetic systems (3) demonstration of field-free spin-orbit torque induced magnetization switching in an antiferromagnet/ferromagnet bilayer system and observation of analogue-like response, which is suitable for applications to artificial intelligences.

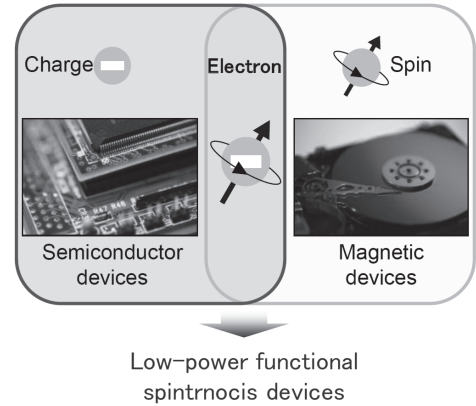

[Staff]

Professor: Hideo Ohno, Ph. D.

Associate Professor: Shunsuke Fukami, Ph. D.

Assistant Professor: Shun Kanai, Ph. D.

Research Fellow: Hsiao Wen Chang, Ph. D.

Research Fellow: Eli Christopher Inocencio ENOBIO, Ph. D.

[Profile]

Hideo Ohno received Ph. D. degree from the University of Tokyo in 1982. He was with the Faculty of Engineering, Hokkaido University as a Lecturer (1982) and then as an Associate Professor (1983). He moved to Tohoku University in 1994 as a Professor. He received the IBM Japan Science Prize (1998), the IUPAP Magnetism Prize (2003), the Japan Academy Prize (2005), Thomson Reuters Citation Laureates (2011), JSAP Outstanding Achievement Award (2011), IEEE David Sarnoff Award (2012), and the 5th Isamu Akasaki Award (2015). He is Institute of Physics (IOP) Fellow (2004), Honorable Professor at Institute of Semiconductors, Chinese Academy of Sciences, JSAP fellow (2007), and APS fellow (2012), Distinguished Professor at Tohoku University (2008), and IEEE Magnetic Society Distinguished Lecturer for 2009.

Shunsuke Fukami received Ph. D. degree from Nagoya University in 2012. He joined NEC Corp (2005). He moved to Tohoku University as an Assistant Professor (2011) and then as an Associate Professor (2015). He received the JSAP Paper Award (2012), the RIEC Award for Tohoku University Researchers (2013), the Funai Research Incentive Award (2014), the JSAP Young Scientist Presentation Award (2014), the Young Scientists' Prize of Science and Technology by the MEXT (2015), and the Harada Young Research Award (2015).

[Papers]

- [1] L. Chen, F. Matsukura, and H. Ohno, "Electric-Field Modulation of Damping Constant in a Ferromagnetic Semiconductor (Ga,Mn)As," *Phys. Rev. Lett.* **115**, 057204 (2015).
- [2] S. DuttaGupta, S. Fukami, C. Zhang, H. Sato, M. Yamanouchi, F. Matsukura, and H. Ohno, "Adiabatic spin-transfer-torque-induced domain wall creep in a magnetic metal," *Nature Phys.* **12**, 333 (2015).
- [3] S. Fukami, C. Zhang, S. DuttaGupta, A. Kurenkov, H. Ohno, "Magnetization switching by spin-orbit torque in an antiferromagnet-ferromagnet bilayer system," *Nature Mater.*, **15**, 535 (2016).

Nano-Molecular Devices

Control of surface and interface of molecular informational devices and development of novel nano-molecular devices

Nano-Molecular Devices: Michio Niwano, Professor

[Research Target and Activities]

Development of the semiconductor nanofabrication technology as typified by photolithography has miniaturized and sophisticated electronic devices. On the other hand, the progress of nanotechnology and biotechnology enables us to synthesize and use biological molecules, supramolecules, and nanostructures with electrically and optically unique features. By combining these technologies, we are aiming to develop molecular scale devices which allow advanced information process.

1. Development of perovskite solar cells: Annealing process is crucial in obtaining high-quality perovskite layers used for highly efficient planar perovskite solar cells. In this study, we have investigated annealing-induced chemical and structural changes of tri-iodide (TI) and mixed-halide (MH) organometal perovskite layers using infrared absorption spectroscopy, scanning electron microscopy and x-ray diffraction measurements. For TI layers, the solvent molecule, dimethylformamide (DMF), remained in the form of PbI_2/DMF compound after drying at room temperature. During annealing, the DMF evaporated to form PbI_2 crystals. When the MH perovskite film was annealed, both $\text{CH}_3\text{NH}_3\text{PbCl}_3$ and $\text{CH}_3\text{NH}_3\text{PbI}_3$ crystals were initially formed from an amorphous phase. With further annealing, the $\text{CH}_3\text{NH}_3\text{PbI}_3$ crystals gradually grew through the incorporation of source materials supplied from the $\text{CH}_3\text{NH}_3\text{PbCl}_3$ crystals and the amorphous phase and the slow evaporation of methylammonium (MA) and chloride ions. The resultant MH perovskite layer after annealing was mainly composed of large $\text{CH}_3\text{NH}_3\text{PbI}_3$ grains with a trace of chloride ions. We suggested that the difference in composition and structure leads to different charge transporting properties of the TI and MH perovskite layers. (*J. Mater. Chem. A*, **3**, 14195 (2015))

2. Fabrication and characterization of p^+i-p^+ type organic thin film transistors: Organic thin film transistors (OTFTs) have been explored because of their advantageous features such as light-weight, flexible, and large-area. For more practical application of organic electronic devices, it is very important to realize OTFTs that are composed only of organic materials. In this paper, we have fabricated p^+i-p^+ type of OTFTs in which an intrinsic (i) regioregular poly (3-hexylthiophene) (P3HT) layer is used as the active layer and highly doped p-type (p^+) P3HT is used as the source and drain electrodes. 2,3,5,6-tetrafluoro-7,7,8,8-tetracyanoquinodimethane (F4-TCNQ) was used as the p-type dopant. A fabricating method of p^+i-p^+ OTFTs have been developed by using SiO_2 and aluminum films as capping layers for micro-scaled patterning of the p^+ -P3HT electrodes. The characteristics of the OTFTs were examined using photoelectron spectroscopy and electrical measurements. We demonstrated that the fabricated p^+i-p^+ OTFTs work with carrier injection through a built-in potential at p^+/i interfaces. We found that the p^+i-p^+ OTFTs exhibit better FET characteristics than the conventional P3HT-OTFT with metal (Au) electrodes, indicating that the influence of a carrier injection barrier at the interface between the electrode and the active layer was suppressed by replacing the metal electrodes with p^+ -P3HT layers. (*J. Appl. Phys.* **119**, 154503 (2016); *Jpn. J. Appl. Phys.*, **54**, 091602 (2015))

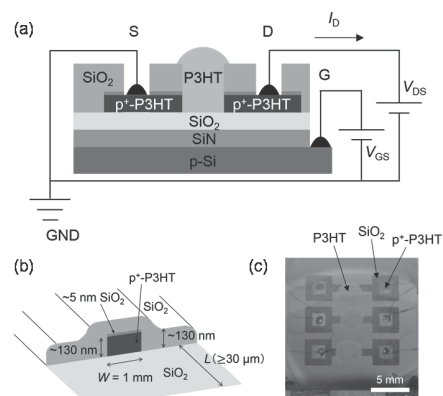

p^+i-p^+ type organic thin film transistors.

3. Investigation of neuronal extracellular recordings: Electrical signals of neuronal cells can be recorded non-invasively and with a high degree of temporal resolution using multielectrode arrays (MEAs). However, signals that are recorded with these devices are small, usually 0.01%–0.1% of intracellular recordings. Here, we show that the amplitude of neuronal signals recorded with MEA devices can be amplified by covering neuronal networks with

an electrically resistive sheet. The resistive sheet used in this study is a monolayer of glial cells, supportive cells in the brain. The glial cells were grown on a collagen-gel film that is permeable to oxygen and other nutrients. The impedance of the glial sheet was measured by electrochemical impedance spectroscopy, and equivalent circuit simulations were performed to theoretically investigate the effect of covering the neurons with such a resistive sheet. Finally, the effect of the resistive glial sheet was confirmed experimentally, showing a 6-fold increase in neuronal signals. This technique feasibly amplifies signals of MEA recordings. (Appl. Phys. Lett., **108**, 023701 (2016))

[Staff]

Professor: Niwano, Michio Dr. Assistant Professor: Teng Ma Dr.

[Profile]

Michio Niwano 1998 – present RIEC, Tohoku University, Japan, Professor, Doctorate of Science.
Memberships: The Electrochemical Society (ECS), The Japan Society of Applied Physics (JSAP), The Surface Science Society of Japan (SSSJ).

[Papers]

- [1] Daisuke Tadaki, Teng Ma, Jinyu Zhang, Shohei Iino, Ayumi Hirano-Iwata, Yasuo Kimura, Richard Rosenberg, and Michio Niwano, "Fabrication and characterization of p⁺-i-p⁺ type organic thin film transistors with electrodes of highly doped polymer." *J. Appl. Phys.* **119**, 154503 (2016).
- [2] Ayumi Hirano-Iwata, Ryosuke Matsumura, Teng Ma, Yasuo Kimura, Michio Niwano, and Kazuo Nishikawa, "Interaction of plasma-generated water cluster ions with chemically-modified Si surfaces investigated by infrared absorption spectroscopy." *AIP Advances*, **6**, 035017 2016.
- [3] Teng Ma, Daisuke Tadaki, Masao Sakuraba, Shigeo Sato, Ayumi Hirano-Iwata and Michio Niwano, "Effects of interfacial chemical states on the performance of perovskite solar cells", *J. Mater. Chem. A*, **4**, 4392-4397, 2016.
- [4] Ryosuke Matsumura, Hideaki Yamamoto, Michio Niwano, and Ayumi Hirano-Iwata, "An electrically resistive sheet of glial cells for amplifying signals of neuronal extracellular recordings." *Appl. Phys. Lett.*, **108**, 023701 2016.
- [5] Hideaki Yamamoto, Takanori Demura, Kohei Sekine, Sho Kono, Michio Niwano, Ayumi Hirano-Iwata, Takashi Tanii, "Photopatterning Proteins and Cells in Aqueous Environment Using TiO₂ Photocatalysis." *Jove-Journal of Visualized Experiments*, **104**, e53045, 2015.
- [6] Michio Niwano, Ayumi Hirano-Iwata, "Biosensing by in situ Infrared Spectroscopy (in Japanese)", **64**(11), 793 (2015).
- [7] Daisuke Tadaki, Teng Ma, Jinyu Zhang, Shohei Iino, Ayumi Hirano-Iwata, Yasuo Kimura, and Michio Niwano, "Molecular doping of regioregular poly(3-hexylthiophene) (P3HT) layers by 2,3,5,6-tetrafluoro-7,7,8,8-tetracyanoquinodimethane (F₄-TCNQ) investigated by infrared spectroscopy and electrical measurements." *Jpn. J. Appl. Phys.*, **54**, 091602, 2015.
- [8] Teng Ma, Matteo Cagnoni, Daisuke Tadaki, Ayumi Hirano-Iwata, and Michio Niwano "Annealing-induced chemical and structural changes in tri-iodide and mixed-halide organometal perovskite layers." *J. Mater. Chem. A*, **3**, 14195-14201 2015.
- [9] Ayumi Hirano-Iwata, Yutaka Ishinari, Hideaki Yamamoto, Michio Niwano, "Micro- and nano-technologies for lipid bilayer-based ion-channel functional assays." *Chem. Asian J.*, **10**, 1266-1274 (2015).

Research Targets and Activities of Laboratory for Brainware Systems

The Laboratory for Brainware Systems of the Research Institute of Electrical Communication was established in 2004 and renewed in 2014. Its purpose is to contribute to the research and development of advanced information science and technology for Brainware systems which realize a seamless fusion of the changeable and complex real world and the cyber space.

We aim at establishing scientific and technological foundations and at exploring human-like brainware computing applications for Adaptive Cognition and Action Systems Division (Recognition and Learning Systems Group), Autonomous Decentralized Control Systems Division (Real-World Computing Group), Brainware LSI Systems Division (New Paradigm VLSI System Group), and brain architecture Division (planned). The Laboratory for Brainware Systems consists of the above four divisions which cooperatively carry out the research. At the same time they serve as a laboratory for nation-wide cooperative research in the field of Brainware systems.

The technology developed in the Laboratory is expected to enhance the research carried out in the four Divisions of the Institute, and the research conducted in the Divisions, in turn, is expected to provide scientific basis for the information technology developed in the Laboratory.

Physical and Adaptive Hardware Environment



• Brain-Like Computing (Brain Architecture)

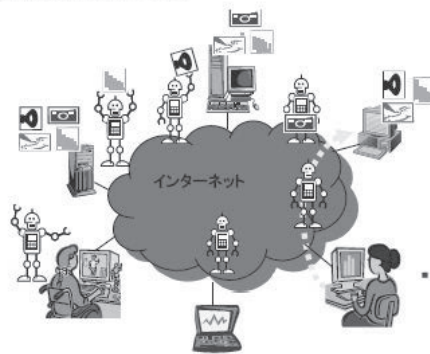

• Real-World Dynamical Intelligence (Real-World Computing)

Seamless Fusion of Real World and Multi-Modal Computing



• Higher-Order Multimodal Perception and Information Generation (Recognition and Learning Systems)

Hardware Environment with Massively Parallel Brain LSI

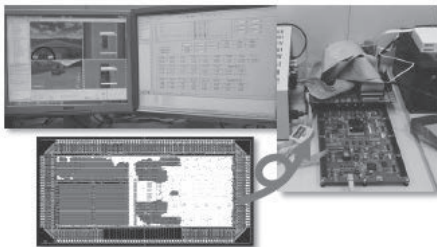

• Asynchronous Network-on-Chip Platform (New Paradigm VLSI System)

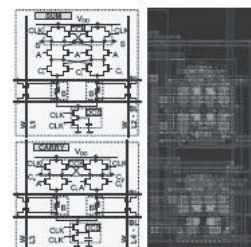

• Nonvolatile Logic and Its Applications (New Paradigm VLSI System)

[Research Target]

Real-World Computing Section: The main contributions achieved in 2014 are summarized as follows: (1) we have proposed a novel measure that can quantitatively measure locomotion patterns of legged animals/robots; (2) we have successfully modeled the inter-arm coordination mechanism underlying ophiuroid locomotion; (3) we have formulated a new decentralized control mechanism for the scaffold-based locomotion of snakes; (4) we have proposed a novel CPG model for bipedal locomotion by exploiting plantar sensation generated by deformable feet; (5) we have proposed a decentralized control mechanism for the interlimb coordination underlying hexapod locomotion.

New Paradigm VLSI System Section: Rapid progress in recent deep submicron regime has led the capability to realize giga-scaled embedded systems on a chip (SoC), while performance degradation of SoCs due to wiring complexity, power dissipation and device-characteristic

variation are increasingly getting serious problems in the recent VLSI chip. Our research activity is to solve the above problems primarily by the following two ways: the use of logic-in-memory architecture based on nonvolatile logic, and the use of asynchronous data-transfer schemes based on multiple-valued current-mode logic, which would open up a novel VLSI chip paradigm, called a “new-paradigm VLSI system.”

Recognition and Learning Systems Section: Humans can perform various actions based on the recognition of the outside world that is constructed through multiple sensory inputs such as vision and touch, even though they frequently move their own body parts in the environment. Here we investigate the adaptive-process and functions of the human cognitive system for action through psychophysical experiments. On the basis of the experimental evidence, we aim to create computational models of the recognition and learning processes in the human brain.

[Research Activities]

Real-World Computing Section: The main contributions achieved in 2015 are summarized as follows: (1) we have proposed a novel decentralized control method on the basis of a concept called TEGOTAE, a Japanese concept describing how well a perceived reaction matches an expectation. We implemented this control mechanism into a snake-like robot, and confirmed that this robot can negotiate unstructured environment; (2) we have investigated the structure of dynamical system underlying the gait transition between middle- and high-speed quadruped locomotor patterns; (3) we have formulated a novel decentralized control mechanism for bipedal locomotion on the basis of TEGOTAE concept. Simulation results strongly suggest that the decentralized control mechanism allows the robot to exhibit adaptive locomotion over slightly uneven terrain.

New Paradigm VLSI System Section: The major contributions achieved in 2015 are summarized as follows: (1) A nonvolatile FPGA (NVFPGA) test chip, where 3000 6-input lookup table (LUT) circuits are embedded, is fabricated under 90nm CMOS/75nm perpendicular magnetic tunnel junction (p-MTJ) technologies. The use of a p-MTJ device makes data-backup-limitation free, which essentially eliminates damage control to nonvolatile storage devices. The use of a p-MTJ device also enables the extension towards dynamically reconfigurable logic paradigm. Since hardware components are shared among all the p-MTJ devices by the use of logic-in-memory structure, the effective area of the 6-input LUT circuit is reduced by 56% compared to that of an SRAM-based one. Moreover, block-level power gating, in which all the idle function blocks are optimally turned off in accordance with the operation mode, can minimize static power consumption of each tile. As a result, the total average power of the proposed NVFPGA is reduced by 81% in comparison with that of an SRAM-based FPGA under typical benchmark-circuit realizations. (2) We also propose a design and proof-of-concept implementation of Gabor filters based on stochastic computation for area-efficient hardware. The Gabor filter exhibits a powerful image feature extraction capability, but it requires significant computational power. Using stochastic computation, a sine function used in the Gabor filter is approximated by exploiting several stochastic tanh functions designed based on a state machine. A stochastic Gabor filter realized using the stochastic sine shaper and a stochastic exponential function is simulated and compared with the original Gabor filter that shows almost equivalent behavior at various frequencies and variance. A root-mean-square error of 0.043 at most is observed. In order to reduce long latency due to stochastic computation, 68 parallel stochastic Gabor filters are implemented in Silterra m CMOS technology. As a result, the proposed Gabor filters achieve a 78% area reduction compared with a conventional Gabor filter while maintaining the comparable speed.

Recognition and Learning Systems Section: First, we investigated whether the relationship with pursuit eye movements is different for fast and slow motion processes, using a motion aftereffect technique with superimposed low- and high-spatial- frequency gratings. Our results reveal that pursuit eye movements and perception share motion signals in both slow and fast motion processes. Second, we investigated how the rotation-independent representation specific to haptic movements is generated. Our results show that rotation-independent representations of haptic movements do not appear when haptic movements passively occur. We also confirmed that active haptic movements generate rotation-independent representations. These results suggest that active movements are required to generate rotation-independent representations for haptic movements.

Recognition and learning systems laboratory

Understanding the human recognition and learning systems

(Visual Cognition and Systems, Satoshi Shioiri, Professor)

Adaptive Cognition and Action Systems, Kazumichi Matsumiya, Associate Professor

(Auditory and Multisensory Information Systems, Shuichi Sakamoto, Associate Professor)

[Research Target and Activities]

To create computational models of the process that the human brain integrates multiple sensory inputs from the outside world, we are investigating the visual and auditory functions in the human brain for implementing these functions in hardware under biologically plausible settings. Our approaches include psychophysics, brain wave measurements, and computer simulations.

First, we investigated whether the relationship with pursuit eye movements is different for fast and slow motion processes, using a motion aftereffect technique with superimposed low- and high-spatial-frequency gratings. We measured the directions of perceived motion and pursuit eye movements to a test stimulus presented after motion adaptation with changing relative contrasts of the two adapting gratings. Pursuit eye movements were observed in the same direction as that of the motion aftereffects, independent of the relative contrasts of the two adapting gratings, for both the static and flicker tests. These results suggest that pursuit eye movements and perception share motion signals in both slow and fast motion processes. Second, we investigated how the rotation-independent representation specific to haptic movements is generated. Our results show that rotation-independent representations of haptic movements do not appear when haptic movements passively occur. We also confirmed that active haptic movements generate rotation-independent representations. These results suggest that active movements are required to generate rotation-independent representations for haptic movements.

[Staff]

Professor : Satoshi Shioiri, Ph.D.

Associate Professor : Kazumichi Matsumiya, Ph.D.

Associate Professor : Shuichi Sakamoto, Ph.D.

[Profile]

Kazumichi Matsumiya, Dr. Matsumiya received Ph.D. degree from Tokyo Institute of Technology in 2000. After then, he worked at Centre for Vision Research, York University in Canada as a postdoctoral fellow. He worked as a researcher at the Imaging Science and Engineering Laboratory, Tokyo Institute of Technology until December, 2003. He worked as a full-time researcher at ATR Human Information Science Laboratories until March, 2005. He joined the Research Institute of Electrical Communication, Tohoku University as a Research Associate in April, 2005. Since then, he has been an Associate Professor from July, 2014.

[Papers]

1. Matsumiya K, Shioiri S: Smooth pursuit eye movements and motion perception share motion signals in slow and fast motion mechanisms. *Journal of Vision* 15(11):12, 1-15, 2015.
2. Matsumiya K, Takahashi M, Kuriki I, Shioiri S: Active movements generate rotation-independent representations for haptic movements. *Interdisciplinary Information Sciences* 21(2), 115-123, 2015.

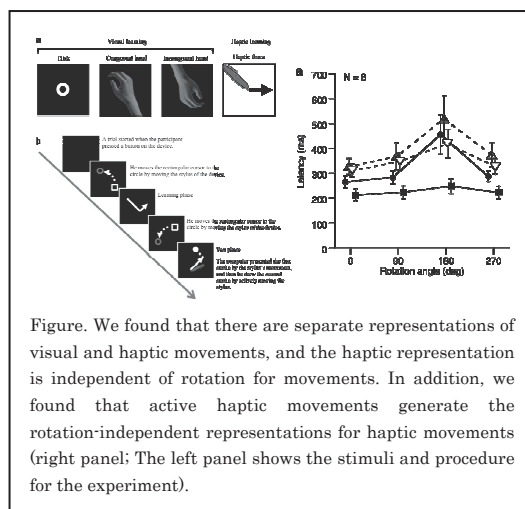

Figure. We found that there are separate representations of visual and haptic movements, and the haptic representation is independent of rotation for movements. In addition, we found that active haptic movements generate the rotation-independent representations for haptic movements (right panel; The left panel shows the stimuli and procedure for the experiment).

New Paradigm VLSI System Research Group

Realization of a New-Paradigm VLSI-Computing World

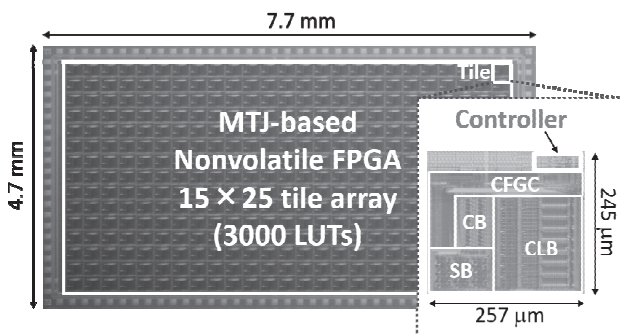

Fig. 1. MTJ-based nonvolatile FPGA with block-level power-gating capability: In each tile, the power supply of all the idle function blocks is turned off by the controller in accordance with the operation mode. As a result, standby power dissipation of the FPGA is almost reduced. In fact, the total power dissipation of the proposed FPGA is reduced by 81% compared to that of the SRAM-based FPGA.

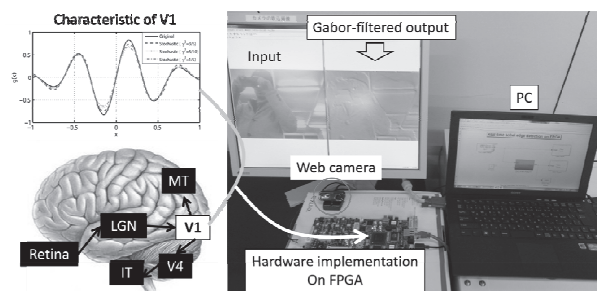

Fig. 2. Brain-inspired feature extraction LSI based on stochastic computation: Gabor filters have similar responses to the primary visual cortex (V1) of brain that exhibits highly feature-extraction capability. Using stochastic computation, the Gabor-filter functions are simply designed on FPGA, reducing the area by 80% compared to a conventional method while maintaining the same throughput.

New Paradigm VLSI System: Takahiro Hanyu, Professor

New Paradigm VLSI Design: Masanori Natsui, Associate Professor

[Research Target and Activities]

Rapid progress in recent deep submicron regime has led the capability to realize giga-scaled embedded systems on a chip (SoC), while performance degradation of SoCs due to wiring complexity, power dissipation and device-characteristic variation are increasingly getting serious problems in the recent VLSI chip. Our research activity is to solve the above problems primarily by the following two ways: the logic-in-memory architecture based on nonvolatile logic, and the brainware LSI (BLSI) computing, which would open up a novel VLSI chip paradigm, called a “new-paradigm VLSI system.”

This year, we have succeeded to design and implement MTJ (Magnetic Tunnel Junction)-based Field-Programmable Gate Arrays (FPGAs) for ultra-low power computing (Fig. 1) and brain-inspired feature-extraction LSIs, called Gabor filtering LSI, based on stochastic computation (Fig. 2).

[Staff]

Professor : Takahiro Hanyu, Dr.

Associate Professor : Masanori Natsui, Dr.

Assistant Professor : Naoya Onizawa, Dr.

Assistant Professor : Daisuke Suzuki, Dr.

[Profile]

Takahiro Hanyu received the D.E. degrees in Electronic engineering from Tohoku University, Sendai, Japan, in 1989. His general research interests include multiple-valued current-mode logic and its application to high performance and low-power arithmetic VLSIs.

Masanori Natsui received the Ph.D. degrees in information Sciences from Tohoku University, Sendai, Japan, in 2005. His research interest includes automated circuit design technique, nonvolatile-based circuit architecture and its application, and design of high speed low-power integrated circuits.

[Papers]

- [1] D. Suzuki, et al., "Fabrication of a 3000-6-Input-LUTs Embedded and Block-Level Power-Gated Nonvolatile FPGA Chip Using p-MTJ-Based Logic-in-Memory Structure," *Digest of Technical Papers, 2015 Symp. on VLSI Circuits*, pp.172-173, June 2015.
- [2] H. Jarollahi, et al., "Algorithm and Architecture for a Low-Power Content-Addressable Memory Based on Sparse Clustered Networks," *IEEE Trans. VLSI Syst.*, vol. 23, no. 4, pp. 642-653, 2015.
- [3] N. Onizawa, et al., "Gabor Filter Based on Stochastic Computation," *IEEE Signal Processing Letters*, vol. 22, no. 9, pp. 1224-1228, 2015.

Real-world Computing

Toward Understanding Design Principle for Life-like Resilient Systems

Real-world Computing Akio Ishiguro, Professor

[Research Target and Activities]

Living organisms exhibit surprisingly adaptive and versatile behavior in real time under unpredictable and unstructured real world constraints. Such behaviors are achieved via spatiotemporal coordination of a significantly large number of bodily degrees of freedom. Clarifying these remarkable abilities enable us to understand life-like complex adaptive systems as well as to construct truly intelligent artificial systems. A prominent concept for addressing this issue is “autonomous decentralized control”, in which non-trivial macroscopic functionalities are emerged via spatiotemporal coordination among vast amount of autonomous components that cannot be explained solely in terms of individual functionality. We study the design principle of autonomous decentralized systems that exhibit life-like resilient behaviors from the viewpoints of robotics, mathematics, nonlinear science, and physics.



Fig.1: Snake-like robot that exhibits scaffold-based locomotion

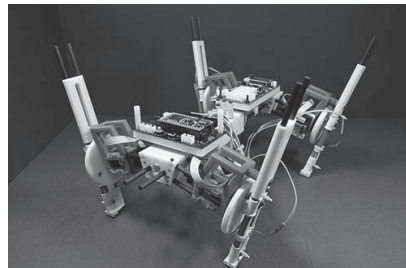

Fig.2: Quadruped robot that exhibit various gait patterns

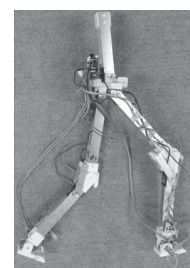

Fig.3: Biped robot with soft deformable feet.

[Staff]

Professor: Akio ISHIGURO, Dr.

Assistant Professor: Dai OWAKI, Dr., Takeshi KANO, Dr., Kazuhiro SAKAMOTO, Dr.

[Profile]

Akio ISHIGURO received B.E., M.E., and Ph.D. degrees from Nagoya University in 1987, 1989, and 1991, respectively. From 1991 to 1997, he was with Nagoya University as an assistant professor. From May 1997 to 2006, he was an associate professor, Nagoya University. From 2006 to 2011, he was a professor of the Graduate School of Engineering, Tohoku University. Since April 2011, he has been a professor of Research Institute of Electrical Communication, Tohoku University. His main research interests are in bio-inspired robotics, nonlinear dynamics. He received 2003 IROS Best Paper Award Nomination Finalist, 2004 IROS Best Paper Award, 2008 Ig Nobel Prize (Cognitive Science Prize), 2009 IROS Best Paper Award Nomination Finalist, 2011 IEEE/RSJ NTF Award Finalist for Entertainment Robots and Systems, 2012 IEEE/RSJ JCTF Novel Technology Paper Award for Amusement Culture Finalist, Living Machines 2012 Best Paper Award.

[Papers]

- [1] D. Nakashima, T. Kano, and A. Ishiguro, How Snakes Move by Selectively Utilizing Reaction Force from Environment, 2015 JSMB-CJK Joint conference, P-25, 2015
- [2] D. Owaki and A. Ishiguro, “A Minimalist CPG Model for Interlimb Coordination in Quadruped Locomotion”, ICRA2015 CPG workshop, *Invited talk*, 2015.
- [3] D. Owaki, S. Horikiri, J. Nishii, and A. Ishiguro, “Experimental Verification of Bipedal Walling Control Exploiting Plantar Sensory Feedback”, AMAM2015, 2015.

IT-21 center**Research and Development of the IT-Based Practical Technology
by the Industry-Academia-Government Collaboration****[Research Target and Activities]**

The purpose of the IT-21 center is development of practical technologies for IT based on the advanced technologies of RIEC with the partnership among Industry, Government and University. The term of development is limited less than 5 years. The projects are planned on matching with both basic technologies in the University and application in the Industry. Combination of the technologies of the University and Industry makes practical technologies with availability for the commercial products. The center actively accelerates to obtain the intellectual properties generated from the development of practical technology to the Industry. Presently, two projects for mobile and storage technologies are being carried out.

1. Development of high-efficient transmission power amplifier module contributing to the low-carbon society

The mobile wireless technology group has been proposing the concept of “Dependable Air,” which is a heterogeneous and highly-reliable wireless network. The Dependable Air is able to work even in the event of a big disaster. For realizing the concept of Dependable Air, the mobile group started “Development of high-efficient transmission power amplifier module contributing to the low-carbon society” from 2015 as the Japan Science and Technology Agency (JST) A-STEP type project. In mobile communication systems, power amplifiers (PAs) are one of the most energy consuming device, and PAs are demanded high linearity and high efficiency. In 2015, we have been proposed a linearity enhancement technique to a CMOS triple cascode push-pull power amplifier by second harmonic feedback. The proposed PA was fabricated in 0.18- μm CMOS process and was implemented on the balun by flip-chip connection.

2. Development of High Availability Information Storage Systems

Severe information loss took place due to damage of storage servers at the Tohoku Earthquake. We started research on reliable information storage with smart file backup and restoration, which contributes to anti-disaster information storage technology. A project “Research and Development on highly-functional and highly-available information storage technology” supported by MEXT started in 2012 under the collaborations of RIEC including IT21 storage technology group, Hitachi, a major Japanese Storage manufacturer, and Hitachi Solutions East Japan. The goal of the project is the development of highly functional and highly available storage system. In 2013, (1) A storage system that realizes 90 % of information can be available even when a half (50%) servers are lost or damaged was developed based on the risk-aware algorithm, (2) Simulation of high-speed data-transfer was carried out for parallel-track storage device and software defined network systems, (3) Prototyping and testing of the highly reliable storage system. In 2015, the developed highly available storage system was implemented into the real local area network of Tohoku University for the final testing scheduled in 2016.

[Staff]

Director: Hiroaki Muraoka, Professor

Project Planning Division

Makoto Furunishi, Visiting Professor

Technology Development Division (Mobile Wireless Technology Group)

Noriharu Suematsu, Professor

Suguru Kameda, Associate Professor

Technology Development Division (Storage Technology Group)

Takaki Nakamura, Associate Professor

IT21 Center Mobile Wireless Technology Group
For Realizing Dependable Air

Noriharu Suematsu, Professor (Project Leader)
Suguru Kameda, Associate Professor

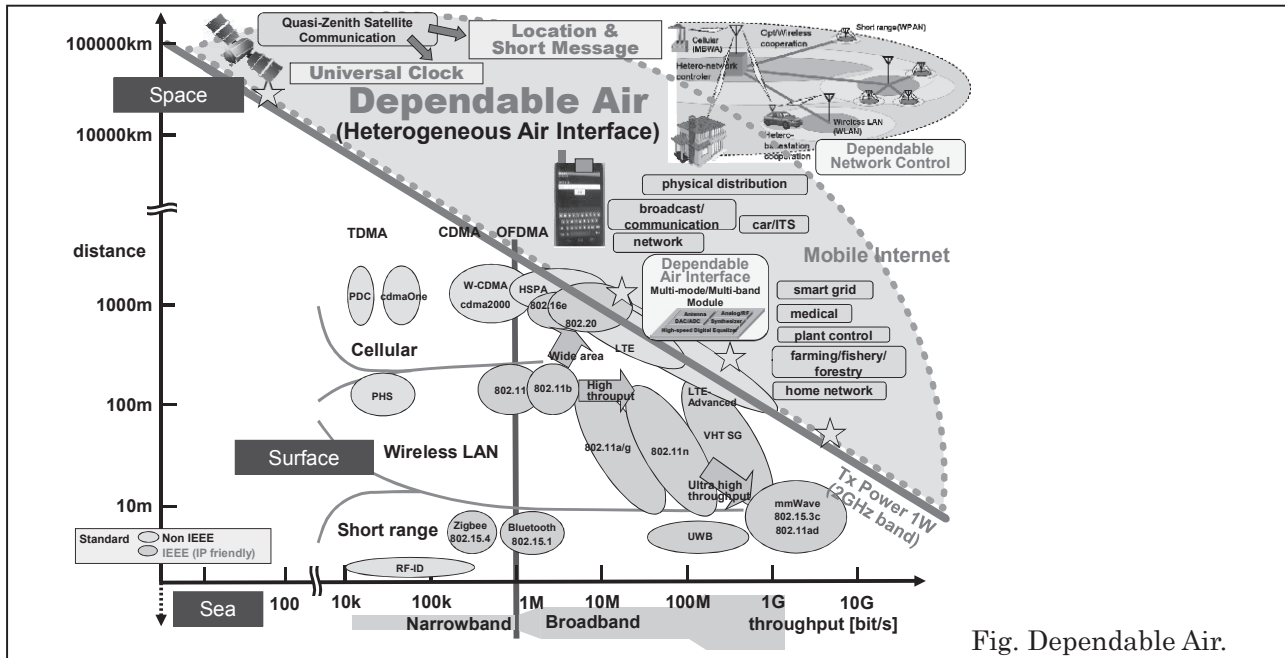

Fig. Dependable Air.

[Research Target and Activities]

Mobile wireless communication technology is one of the significant communication technologies that support the Information and Communication Technology (ICT) society, connected with the high-speed backbone network using optical fiber. Evolution of the mobile wireless communication technology in Japan is indispensable to keep the leadership in this technology area in the world. The mobile wireless technology group has been proposing the concept of “Dependable Air,” which is a heterogeneous and highly-reliable wireless network. The Dependable Air is able to work even in the event of a big disaster. For realizing the concept of Dependable Air, the group started the Japan Science and Technology Agency (JST) A-STEP type project “Development of high-efficient transmission power amplifier module contributing to the low-carbon society” from 2015. In addition, our group would like to contribute to the local industries in Tohoku area including the establishment of venture companies based on our developments.

[Staff]

Professor: Noriharu Suematsu, Ph. D
Associate Professor: Suguru Kameda, Ph. D

[Papers]

- [1] K. Tsubouchi, S. Kameda, A. Taira, N. Suematsu, and T. Takagi, “Dependable air – Network selection scheme using positioning information and traffic navigation for heterogeneous wireless network,” IEICE Fundamentals Review, vol.9, no.1, pp.37-46, July 2015.
- [2] T.T. Ta, S. Tanifuji, A. Taira, S. Kameda, N. Suematsu, T. Takagi, and K. Tsubouchi, “A millimeter-wave WPAN adaptive phased array control method using low-frequency part of signal for self-directed system,” IEEE Trans. Microw. Theory and Techn., vol.63, no.8, pp.2682-2691, August 2015.
- [3] K. Terajima, K. Fujii, T. Takagi, K. Tsubouchi, S. Kameda, and N. Suematsu “A 2GHz band ultra small balun with second harmonic branching filter using CMOS Process,” IEICE General Conference, C-2-55, March 2016 (in Japanese).

IT21 Center Storage Technology Group

Realization of Highly-available Storage System

Takaki Nakamura, Associate Professor

Hiroshi Matsuoka, Visiting Professor

Application on Smart Phone Working with
Highly-Available Storage SystemA Snapshot in Field Test of
Highly-Available Storage System**[Research Target and Activities]**

The Storage Technology Group continue to be engaged in the research and development of storage technology in a collaboration between industry, academia, and government. Our group successfully completed two national projects commissioned by the Ministry of Education, Culture, Sports, Science and Technology from FY2002 to FY2011.

Recently, as social and information systems become more complicated, one of the urgent research areas in storage, in addition to “devices” and “drives”, is the “system”. Because of this our group started a new national project “Research and Development on Highly-functional and Highly-available Information Storage Technology” in FY2012. The project will continue until FY2016. Furthermore, in collaboration with the storage system industry, we will focus on bringing the results of our research into practical use within five years, which is the prime mission of the IT-21 center.

[Staff]

Associate Professor: Takaki Nakamura, Ph.D.

Visiting Professor: Hiroshi Matsuoka, Ph.D.

Research Fellow: Masachika Harada

[Profile]

Takaki Nakamura received B.E, M.E, and Ph.D. in information science from Osaka University in 1996, 1998, and 2011 respectively. He joined Central Research Laboratory, Hitachi, Ltd. in 1998. He is currently an associate professor at RIEC, Tohoku University. He has been engaged in research on storage system.

[Papers]

- [1] Takaki Nakamura, Shinya Matsumoto, and Hiroaki Muraoka, “Discreet Method to Match Safe Site-Pairs in Short Computation Time for Risk-aware Data Replication,” IEICE Transactions on Information and Systems, Vol. E98-D, No. 8 (2015), pp. 1493-1502.
- [2] Takaki Nakamura, Shinya Matsumoto, Masaru Tezuka, Satoru Izumi, and Hiroaki Muraoka, “Comparison of Distance Limiting Methods for Risk-aware Data Replication in Urban and Suburban Area,” Journal of Information Processing, Vol. 24, No. 2 (2016), pp. 381-389.

Management Office for Safety and Health

Realizing and Maintaining a Safe and Comfortable Environment to Support Research

[Research Target and Activities]



Safety and health seminar



First aid training course

1. Outline of the Management Office for Safety and Health

The Management Office for Safety and Health is established to maintain the safety and health of students and staff working at the institute. The use of chemicals, high-pressure gas and radiation in research activities at the institute entails many risks. The Management Office for Safety and Health provides support for safety and health management in research laboratories, experimental facilities and the Fundamental Technology Center through various activities to ensure safe and smooth research activities within the institute.

2. Activities by the Management Office for Safety and Health

For the actual management of safety and health at the office, the Safety and Health Committee first presents the basic policies of safety management at the institute, and the Management Office for Safety and Health then plans and executes activities based on them. At the institute, laboratories and other individual sections are highly independent of each other; unlike a general corporate organization, top-down safety management is not suitable and measures appropriate for independent sections need to be taken. Various considerations are also necessary for students, researchers, and other members engaged in research activities as well as faculty staff. At this institute, extremely hazardous materials and facilities are used, including chemicals, high-pressure gas, and X-ray devices. Since there is also a clean room and other special workplaces, safety management should be extended by considering them. In these circumstances, the Management Office for Safety and Health will monitor situations and characteristics in each section at the institute, plan and recommend practical management methods and improvement measures, and support their implementation for the efficient and effective management of safety and health. The main activities in this fiscal year are as follows:

- Holding safety and health seminar and high-pressure gas seminar for staff and students at the institute
- Inspection of and assistance in improving the safety and health management system and working environment within the institute
- Holding first aid training course
- Investigation of laws related to safety and health and collection of information regarding safety and health management
- Providing advice and information to safety and health personnel in each department

[Staff]

Manager: Satoshi Shioiri, Professor

Deputy Manager: Yoichi Uehara, Professor

Nobuyuki Sato, Assistant Professor

Maho Abe, Technical Staff Yoshiko Kikuta, Clerk

Flexible Information System Center

Development and Management of Flexible Information System

[Research Target and Activities]

The present information systems represented by computers are inflexible systems, because their uses are predefined and they provide only the fixed processing and functions. The flexible information system on the other hand, is a system which can perform the flexible information processing adapted to the human intention and situation of its environment beyond the limitations of the principles of the inflexible information processing. The aims of this center are to manage and operate information networks and systems based on the concept of the flexible information system, and support smooth research activities of RIEC.



Figure 1 RIEC network system

Moreover, utilizing technical know-how acquired through applying the information networks and systems to practical use, we also design and construct a leading-edge system for advanced organization, utilization, administration, operation and dispatching of scientific information.

1. Information collection, organization, dispatching, utilization and research support environment.
2. Advanced maintenance, management and operation of network.
3. Technical supports for information networks and systems in the institute.

[Staff]

(1) Steering Committee

Professor: Tetsuo Kinoshita, Dr., Yôiti Suzuki, Dr., Yoshihito Toyama, Dr., Masafumi Shirai Dr., Atsushi Ohori, Dr., Takuo Suganuma, Dr.

(2) FIR Committee

Professor: Yoshihito Toyama, Dr., Takuo Suganuma, Dr.

Associate Professor: Masato Yoshida, Dr., Gen Kitagata, Dr.

Assistant Professor: Hisanao Akima, Dr., Dai Owaki, Dr., Katsuhiko Ueno, Dr., Kazuto Sasai, Dr.

Technical Official: Masahiko Sato, Kenji Ota

Technical Support Member: Keiko Taniguchi, Ayano Yoshihara

(3) Regular Staff

Associate Professor: Gen Kitagata, Dr.

Assistant Professor: Kazuto Sasai, Dr.

Technical Official: Masahiko Sato, Kenji Ota

Technical Support Member: Keiko Taniguchi, Ayano Yoshihara

[Profile]

Refer to the Communication Network Laboratory for the profile of Prof. Tetsuo Kinoshita.

Refer to the Computing Information Theory Laboratory for the profile of Prof. Yoshihito Toyama.

Fundamental Technology Center

Supporting research with high-level specialized knowledge and technology

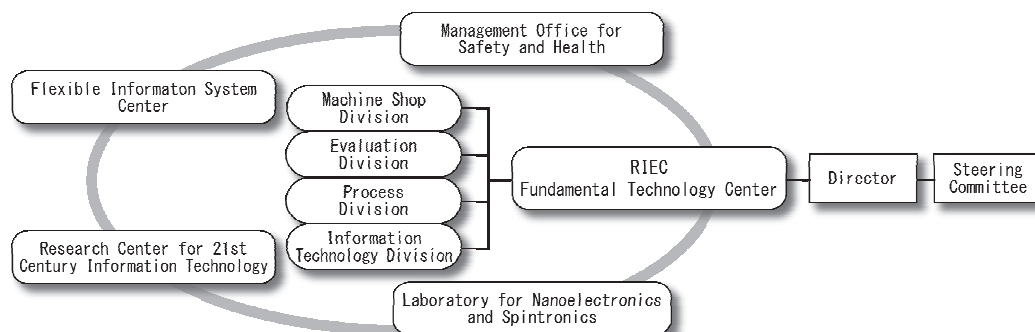

Overview of Fundamental Technology Center

[Research Target and Activities]

The Fundamental Technology Center provides a wide range of technical supports for research and development (R & D) through the following four divisions; machine shop, evaluation, process, and information technology. The activities of the present year are summarized as follows except for those of Technical Official F. Saito which are separately described in the sections of Advanced Acoustic Information Systems respectively.

1. Machine Shop Division

The Machine Shop Division supplied machining products of 125, following requests from researchers. About 30 % of the requests were from the outside of the institute.

2. Evaluation Division

20 laboratories utilized evaluation and measurement apparatuses for shared usage (the utilization time was 4331 hours in total), and furthermore there was utilization from the outside of university. Glass processing products of 6 were supplied. Several services relating to supply of cryogenic liquids were provided.

3. Process Division

This division supplied electron-beam lithographic products of 279, in cooperation with technical office, Laboratory for Nanoelectronics and Spintronics. Technical supports were provided for operating and maintain clean rooms of Laboratory for Nanoelectronics and Spintronics. In addition, optical multilayered thin films were supplied to the outside of the university.

4. Software Technology Division

This division operated the in-house network at the institute and maintained shared-use-information-equipment, in cooperation with Flexible Information System Center. This division also engaged in contracting affairs of collaborative research based on intellectual-property rights and in giving advices to researchers who tried to apply patents.

[Staff]

Director (Professor): Yoichi UEHARA.

Assistant Professor: Nobuyuki SATO.

Technical Officials: Koichi SHOJI, Tamotsu SUENAGA, Kento ABE, Yasuaki MAEDA, Maho ABE, Takenori TANNO, Iori MORITA, Rikima ONO, Masahiko SATO, Yuko MARUYAMA, Kenji OHTA, Fumitaka SAITO, Katsumi SAGAE, Keiko TANIGUCHI, Ayano YOSHIHARA, Toshiko ISHIKAWA, Sachiko INOOKA.

Ad-hoc research groups

Taking advantage of the wide range of expertise in the institute, ad-hoc research groups are formed outside of the formal organizational structure to investigate challenging exploratory topics and needs-based, cutting-edge subjects.

[Group of multimodal attention]

It is crucial to select information from input signals to process, and to select action from infinite number of possibilities for human to live in the world with full of complicated objects changing dynamically. We focus on the attention process for action as well as for cognition in the study. Assuming that attention for action is based on a space representation that unifies signals from different modalities, we investigate the mechanism of attention for action. In this year, we discussed the possibilities of experimental approach for the purpose using a technique developed for visual attention and we made a plan of the study to submit application for KAKENHI.

[Next-Generation Nitride Electron Device Research Group]

GaN-based semiconductors are promising candidates for high-speed and high-power transistors for communication systems, vehicle applications and so on as well as blue and white LEDs. The goal of our study is to realize new GaN-based high-power RF transistors that help enhance the power efficiency by combining the advanced material technology developed at the Institute for Materials Research and the cutting-edge device technology developed at RIEC. We started a study on the nitrogen-polar GaN that has a potential to achieve superior transistor performance than the conventional GaN material system. A nitrogen-polar GaN/AlGaN heterostructure has been successfully grown and the electrical characterization has confirmed the existence of the two-dimensional electron gas that will be an important current path when we make a transistor.

[Time salon : research group investigating the concept of time]

Time is one of most fundamental concepts created by human beings; through time constructing, we would obtain the ability to perceive the space, our bodies, and relationships to others. The ultimate goal of this research group is to discover the principles of human's time construction, and to develop a model of human cognition and control. To approach this goal, the group attempts to develop a model of time construction that underlies human perception through philosophical observation and scientific experimentation. In this academic year, we have held 12 discussion meetings, the "time salons", and have analyzed and discussed diverse topics related to human's time construction, ranging from Kant's transcendental deduction of time to recent findings in cognitive science and neural science, and have come up with some observations. We hope to continue pursuing the research and to design some experiments of verifying our observations.

Center for Spintronics Integrated Systems (CSIS)

<About the Center>

Establishment : CSIS, which was established on March 10th 2010 in order to implement the FIRST Program, is conducting research and development of ultra-low power spintronics-based VLSIs.

Organization :

- Director : Hideo Ohno (Professor and Director of RIEC)
- Number of Researchers : 23 (including 17 concurrent appointments)

Research Target : CSIS has been advancing the following programs to assume a leading role in innovative change by demonstrating the fusion of spintronics devices and logic integrated circuits, thus aiming at playing a pivotal role in the global innovation cycle of VLSIs.

○“Distributed IT system project (project leader : Prof. Hideo Ohno)” in ImPACT program (program manager : Prof. Masashi Sahashi) of CSTI, 2015/10/2~

Research Activities : Research and development of spintronics device, 300mm integration process technology, innovative circuit and the architecture technology, and realization of low power consumption microcontroller driven by energy harvesting

<Major Achievements in 2015>

(1) Observation of different temperature dependence of energy barrier in CoFeB-MgO magnetic tunnel junctions depending on their sizes, which can be explained by a difference in the magnetization reversal mode. (2) Evaluation of thickness dependence of damping constant for single-interface and double-interface CoFeB-MgO structures from a ferromagnetic resonance using a vector network analyzer. (3) Demonstration of the third scheme of spin-orbit torque induced magnetization switching that is useful to investigate the physical mechanism of the switching. (4) Demonstration of nonvolatile associative processor for image recognition to achieve the world's lowest (600 μ W) operation power based on the 300mm-wafer 90nm-CMOS/70nm-perpendicular-MTJ hybrid process.

○“Research and Development of Spintronics Material and Device Science and Technology for a Disaster-Resistant Safe and Secure Society (principal investigator: Prof. Hideo Ohno)” under “R&D Project for ICT Key Technology” of MEXT, 2012/8/15~

Research Activities : Research and development of spintronics material and device for high functionality (high speed)/ ultra-low power consumption (high capacity) working memory at technology node of less than 20 nm, and study on simulation of disaster-resistant computer system.

<Major Achievements in 2015>

(1) Evaluation of width dependence of thermal stability of domain wall in ferromagnetic Co/Ni nanowires and clarification of the mechanism that governs the thermal stability factor of domain walls. (2) Evaluation of dot size dependence of threshold current density for spin-orbit torque induced magnetization switching in nanoscale Ta/CoFeB/MgO dots and clarification of factors that determine the threshold current density. (3) Demonstration of field-free spin-orbit torque induced magnetization switching in an antiferromagnet/ferromagnet bilayer system and observation of analogue-like response, which is suitable for applications to artificial intelligences.

Research Organization of Electrical Communication (ROEC)

Towards Construction of Disaster-Resistant Information Communication Network

[Purpose of our establishment]

Many serious problems have become clear as a result of the Great East Japan Earthquake, which exposed the weaknesses of the most advanced information communications network in the world by severing the mobile phone and optical fiber lines thus cutting off essential telecommunications services. To solve these problems, Tohoku University's Disaster Reconstruction and Regeneration Research Project includes an ICT Reconstruction Project for restoring information communication. The mission given to the researchers in the Electrical Engineering and Information Sciences group after the disaster was to achieve a disaster-resistant information communication network through the ICT Reconstruction Project, taking the needs of the disaster areas into consideration.

To realize this network, we needed to employ the combined strength of our problem-solving abilities by linking researchers in electrical engineering and the information sciences across multiple faculties, including the School of Engineering, the Graduate School of Information Sciences, the Graduate School of Biomedical Engineering, the Cyberscience Center, and the Research Institute of Electrical Communication. These faculties and schools came together to form a new organization that could create close and flexible links between researchers and organizations, and on October 1, 2011 we established the Research Organization of Electrical Communication (ROEC) (Fig.1). The ROEC intends to take an all-Japan approach based on collaboration between industry, academia and government, and assemble expertise from the university with the participation of related local governments, private companies, public research organizations, and other universities with the goal of developing the most advanced disaster-resistant information communication network in the world (Fig.2).

[Main Activities]

Since 2012, we have been promoting 12 disaster-resilient ICT projects supported by the Ministry of Internal Affairs and Communications. In 2015, two ongoing projects were promoted. We have also been engaged in a disaster information delivery project in Cross-ministerial Strategic Innovation Promotion Program (SIP) promoted by the Cabinet Office and a disaster management project supported by RISTEX, JST. In addition, we demonstrated the feasibility of the research results concerning the disaster-resilient ICT system at the disaster-response drill of headquarter in Tohoku University. The research results produced by the promoted projects were presented at the Innovation Fair, Disaster Reconstruction and Regeneration Research Symposium of Tohoku University, and Disaster-resilient ICT Research Symposium of NICT. Our activities were also described in ROEC Newsletters published in 2015.



Fig.1 Research Organization of Electrical Communication.

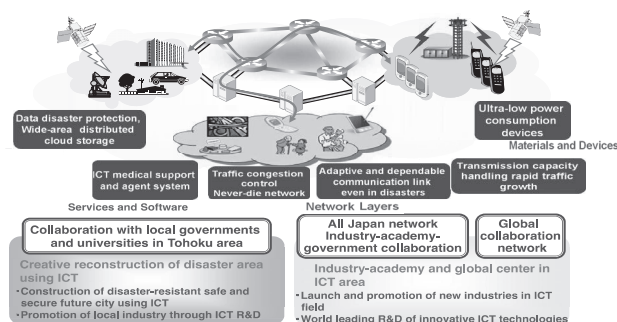

Fig.2 Overview of ICT Reconstruction Project.

[Staff]

Prof. Nei Kato (Executive Director)

Prof. Masayuki Kawamata (Vice Executive Director)

Specially Appointed Prof. Yasushi Sakanaka (Vice Executive Director)

Specially Appointed Prof. Katsumi Iwatsuki (Research Administrator)

Mr. Yasuharu Ito (Office Manager)

Mr. Syuichi Terashima (Manager)

Ms. Izumi Ishikawa (Secretary)

[Papers]

[1] M. Nakazawa, "Optical and wireless-integrated next-generation access network based on coherent technologies," IEICE Society Conference 2015, CK-3-6 (invited talk), 2015.9.9 (in Japanese).

[2] Zubair Md. Fadlullah, et al., "Field Measurement of an Implemented Solar Powered BS-based Wireless Mesh Network," IEEE Wireless Communications Magazine, vol. 22, no. 3, pp. 137-143, Jun. 2015.

[3] Kentaro Inui, "Modeling "Reading between the Lines" Based on Scalable and Trainable Abduction and Large-scale Knowledge Acquisition", Workshop on Deep and Large-Scale Semantic Processing: The Way Ahead. Trento, March 2015.

Center for Innovative Integrated Electronic Systems (CIES)

<Overview>

Establishment: CIES was established in October 2012 to enhance industry-academic collaborations and contribute to the further development of integrated electronic industry. The building was constructed in March 2013 as the first research center by private investment in Science Park at Tohoku University's Aobayama New Campus.

Organization: Director: Tetsuo Endoh (Professor, Graduate School of Engineering)

Number of staff: 60 (including appointments across RIEC, Graduate School of Engineering, Graduate School of Information Sciences, etc)

Mission: CIES aims to contribute to the enhancement of global competitiveness in the field of next generation integrated electronics systems, and further, work toward the creation of practical applications and new industries, through the research and development of innovative devices and its integrated electronic systems and constructing a consortium for this field under the international collaboration among industries, universities and government.

Research topics: Research and development by industry-university joint research projects, national research projects, community-based cooperation projects and so on in the field of IT including electronic device components such as for next-generation semiconductor memory, high-performance printed-circuit board, packaging, and image processing technologies, and in the field of car-electronics including electronic automotive components.

<Major activities in FY2015>

Toward practical applications from innovative core technologies created by Tohoku University, we managed the international industry-academic consortium (CIES Consortium) consisting of seven industry-academic collaborations, three major national projects (JST-ACCEL, ImPACT and NEDO projects), and community-based cooperation projects through our cooperation with a diverse range of Japanese and foreign companies from fields such as materials, equipment, devices, circuits and systems, and achieved remarkable results. CIES promoted to enlarge the base for collaborative research between industry and academia with world-first 300mm wafer process line and facilities for prototype manufacturing and characterizing spintronics integrated circuits compatible with world-class companies. So far, dozens of Japanese and foreign companies have participated in the consortium by accelerating system reforms including intellectual property management, common facility uses and so on to promote industry-academic collaborations. In addition, the companies utilized "a special private-sector investment promotion zone system (for information service-related industries)" under a joint application from Miyagi prefecture and local municipalities, and "financial assistance according to the amount of property tax paid (created under an agreement between Tohoku University and the city of Sendai)". CIES have succeeded in developing the world's largest consortium centering on non-volatile memory (STT-MRAM) and expanding into regional cooperation.

CIES has developed multiple innovative technologies, including next generation memories, high

performance board and package technologies, image processing and so on. Especially, 1M STT-MRAM chip with the world-highest access speed of 2GHz has successfully developed in R&D on STT-MRAM. Keyshight Technologies, Inc. announced to commercialize new STT-MRAM test solution based on collaboration with CIES by 2016. Thus, some of them have been emerged as the successful results in view of the production phase.

We started a technology matching program for regional and local companies with cooperation of Miyagi Prefecture, the Miyagi Advanced Electronics and Machinery Industry Association, the Miyagi Automotive Industry Promotion Council, the Tohoku Bureau of Economy, Trade and Industry and other partners. CIES launched three community-based cooperation projects (one of them, NEDO project for bridging between research institutes and small/mid-sized companies was adopted.) for putting to commercial use of the core technologies, and contributed to rebuild the Tohoku area and assist the region.

Furthermore, CIES internship program has been continued, which contributed to high-level human resources training for forging the future of this field.

Spintronics Research and Education Promotion Office

<Overview>

Establishment: December, 2014

Organization:

- Chair of Steering Committee: Executive Vice President (for Research) Sadayoshi Ito
- Steering Committee: 10 members

Mission:

- Discussing the items related to promotion of spintronics R&D in Tohoku University
- Liaison and coordination between relevant departments in Tohoku University

Activities:

- (1) Sharing information and innovative technologies on spintronics in Tohoku University
- (2) Promotion of spintronics research and training young researchers and students through the collaboration among research groups within and beyond Tohoku University
- (3) Establishment of "Center for 'spintronics research innovation and cooperative network' " according to "Basic concept on promotion of large-scale research project –Drawing-up roadmap– Roadmap 2014"
- (4) Other necessary items concerned with spintronics R&D

<Major activities in 2015>

The second Steering Committee was held on November 17, 2015. The request for budgetary appropriations was approved to establish Center for Spintornics Research Network in Tohoku University. To foster international as well as domestic collaboration in spintronics to enhance existing areas of research and to create new areas aiming at deepening science and creating new branches of industry, this center will promote cooperative research and be the hub of a network with other research institutions within Japan and overseas. As a result, Spintronics Research and Education Promotion Office was abolished at the end of the FY2015.

Leading Graduate Program

Interdepartmental Doctoral Degree Program for Multi-dimensional Materials Science Leaders

<Overview>

Establishment: October , 2013

Organization:

- Program manager: Executive Vice President (for Education, Student Support and Student International Exchange) Kimio Hanawa
- Program coordinator: Professor Tetsuya Nagasaka (Graduate School of Engineering)
- Program member: about 60 Professors in Tohoku University

Mission:

- Cultivating human resources through creating leaders who have a firm grasp of the fundamentals of material science and extensive research experience
- The term “multi-dimensional” (MD) refers to the extensive, panoramic perception of materials through dimensions such as functionalities, characteristics, processes, environmental compatibility, economics, safety, and assessment techniques.

<Major activities in 2015>

About 20 new students joined the program and in 2015. About 40 students in total learned the fundamental and specialized subjects and joined long-term internship at domestic corporations and/or foreign institutions.

A group of interested students participated in the study tour on February 15-16, 2016. They visited National Institute of Advanced Industrial Science and Technology (AIST), National Institute for Materials Science (NIMS), Japan Aerospace Exploration Agency (JAXA) and Hitachi Research Laboratory.

The second joint symposium co-organized by two Leading Graduate Programs, i.e. MD Program in Tohoku University and Ambitious Leader’s Program in Hokkaido University, was held in March, 2016 at Hokkaido University.

Graduate Program in Spintronics (GP-Spin)

<Overview>

Establishment: April 1, 2015

Organization:

- Program manager: Executive Vice President (for Education, Student Support and Student International Exchange) Kimio Hanawa
- Program leader: Professor Yoshiro Hirayama (Graduate School of Science)
- Program member: about 10 Professors in Tohoku University
- Foreign organization: Johannes Gutenberg Univ. Mainz (Germany), Tech. Univ. München (Germany), Tech. Univ. Kaiserslautern (Germany), Tech. Univ. Delft (The Netherland), Univ. Groningen (The Netherland), Univ. Chicago (USA), Univ. New South Wales (Australia)

Mission:

- Education of world-class leaders in spintronics from fundamental to applications

Activities:

- Education by world-leading professors from all departments and institute in Tohoku University with participation from all over the world
- Joint education with foreign organization including joint supervised degree/joint degree, mutual visit and long-term internship, international school/workshop, qualifying examination to guarantee the educational quality

<Major activities in 2015>

In FY2015, ten invited researchers, including Prof. Klaus von Klitzing who is a Nobel Prize Laureate in Physics, visited Tohoku University from abroad. They attended as keynote or invited speakers at the International Workshops* at “Tohoku Forum of Creativity” or held Seminars for students of this program. They also had intensive discussions with students and researchers during their stay in Sendai.

*International Workshops at “Tohoku Forum of Creativity”

- Quantum Nanostructures and Electron-Nuclear Spin Interactions
- Spintronics with Antiferromagnets
- Spintronics (13th RIEC International Workshop on Spintronics)

Program for Key Interdisciplinary Research

Research platform for Yotta-scale data science

<Project outline>

Founded : October 2015

Organization :

Yotta Informatics Research Center (Project leader: Hiroaki Muraoka, RIEC, Professor)

Project members: 26 experts from eight departments.

Purpose of the research:

Novel science and technology to manage both quantity and quality of yotta-scale information, in order to establish the future ICT technology and new humanics by collaborative work of engineering and human and social science

Research :

The amount of information is rapidly increasing, which is projected to reach to the amount of one yotta bytes, one trillion times of one Tera-bytes, or 10 to 24^{th} bytes. Ordinary extension technology of the conventional ICT cannot cope with such gigantic amount of information, therefore essential paradigm change for the information processing is indispensable. In this project, we aim at the new information science, which can manage the quality of information as well as the information amount. For the sake, experts of information engineering, human and social science from departments are discussing about interdisciplinary collaborating works to understand the quality and value of information, as well as the quantity. The value information is the key properties for the future informatics to receive the full benefit of the information in the upcoming “beyond the big data” era.

<Major achievement in 2015>

1. Meeting and discussions by the all project members

The meetings were held five times in total to discuss about the information quality and value. Twenty presentations by the members were presented. These discussions contributed to mutual understanding of the members to establish the research organization

2. Survey of previous studies

Previous studies on the information quality was investigated. The research activities on the quality of information products were founded by MIT (US), Oxford University (UK) etc.

3. Algorithm of the information quality

Analysis algorithm is investigated so as to extract values from the large information based on its quality. The information processing is carried out by the human approach based on the objective measurable properties.

4. Nation-wide Cooperative Research Projects

The Institute has a long history of fundamental contributions in many fields of engineering and science that include the fields of semiconductor materials and devices, magnetic recording, optical communication, electromagnetic technology, applications of ultrasonic communication and acoustic communication, non-linear physics and engineering, and computer software. On the basis of this rich historical background the Institute was designated as a National Center for Cooperative Research in 1994. Accompanying Tohoku University’s transformation to “a national university juridical entity” in April, 2004, this institution plays a leading role on the world stage, as its researchers, both domestic and foreign, continue the task of “investigating the theory and application of universal science and technology to realize communication, to the enrichment of humanity.”

With this background, the Institute organizes Nation-wide Cooperative Research Projects by coordinating its activities with research workers. The main themes for Cooperative Research are selected annually by the Committee for Cooperative Research Projects. Then invitations for project proposals and participation are extended to university faculties and government laboratories as well as industrial research groups. Each project approved by the Faculty Council of the Institute is carried out by a team of researchers that include members of the Institute as well as outside participants.

The Advisory Council which includes members from other institutions has an advisory function to the Director in defining the general direction of the research at the Institute and its Nation-wide Cooperative Research Projects.

The Project Selection Committee that includes members from outside of Tohoku University has a Judging function for project proposals. The purpose of the Project Steering Committee is the proper operation of approved projects.

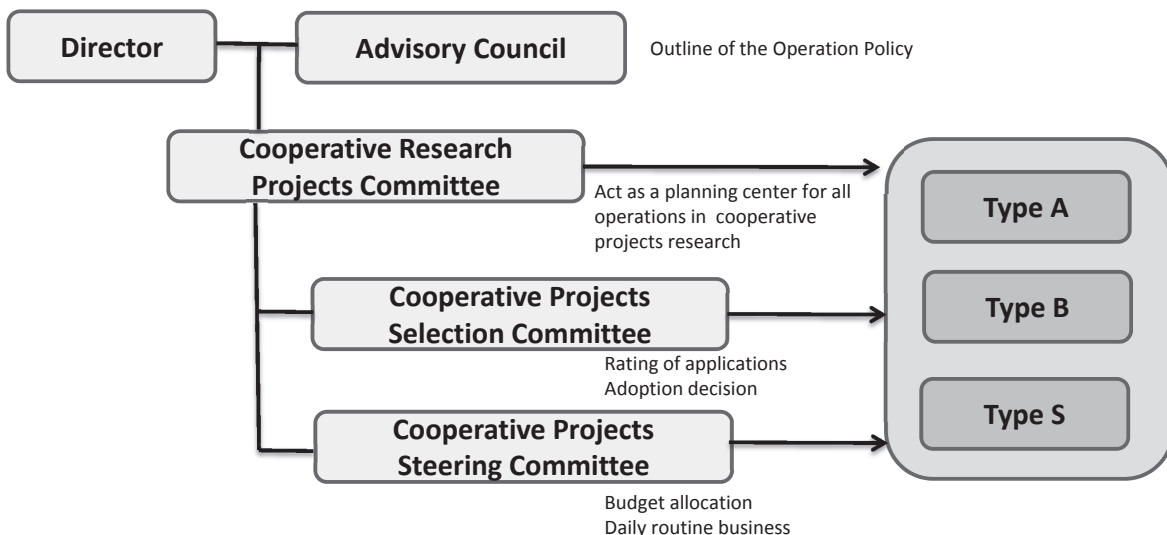

Nation-wide cooperative research projects list 2015

Project Number ----- Research Project Theme	Project Leader	Facilitator in RIEC
H25/A01 ----- Fabrication and characterization of nanometer-scale chalcogenide structures, and their application to memory devices	Masashi Kuwahara National Institute of Advanced Industrial Science and Technology	Yoichi Uehara
H25/A02 ----- Study on High-Power Terahertz Signal Source with InGaAs HEMTs	Yohtaro Umeda Tokyo University of Science Faculty of Science and Technology Electrical Engineering	Tetsuya Suemitsu
H25/A03 ----- Self-assembling formation of high density ferromagnetic nanodots by controlled alloying of group IV semiconductors with metals and its magnetic properties	Seiichi Miyazaki Graduate School of Engineering, Nagoya University	Michio Niwano
H25/A04 ----- Electronic structure and properties of ferromagnetic shape memory and other functional magnetic materials	Shin Imada College of Science and Engineering, Ritsumeikan University	Masafumi Shirai
H25/A05 ----- Implementation of Large Scale Superconducting Quantum Detectors for Practical Applications	Satoshi Kohjiro National Institute of Advanced Industrial Science and Technology	Shigeo Sato
H25/A06 ----- High-precision communication system for kansei information of speech	Akihiro Tanaka Tokyo Woman's Christian University	Shuichi Sakamoto
H25/A07 ----- Multi-channel color representation in human brain	Ichiro Kuriki Research Institute of Electrical Communication, Tohoku University	Ichiro Kuriki
H25/A08 ----- Development of speech processing technology by nonlinear time-varying auditory representation	Masanori Morise Interdisciplinary Graduate School of medicine and Engineering, University of Yamanashi	Shuichi Sakamoto

Project Number	Project Leader	Facilitator in RIEC
Research Project Theme		
H25/A09 Study of the cooperative environment for building visual cognition models	Ko Sakai Faculty of Engineering, Information and Systems, University of Tsukuba	Satoshi Shioiri
H25/A11 Study of Information Principle of Brainware and its applications	Toshiyuki Kanoh NEC Corporation	Takahiro Hanyu
H25/A12 Heterarchical analysis of adaptability under indeterminacy and its technological applications	Tatsuji Takahashi School of Science and Engineering, Tokyo Denki University	Kazuto Sasai
H25/A13 A Study for Persons, Space and Information Technologies	Ikuo Daibo Motivation and Behavioral Sciences, Tokyo Future University	Yoshifumi Kitamura
H26/A01 Development of graphene-based electronic and photonic devices	Takashi Uchino Tohoku Institute of Technology	Taiichi Otsuji
H26/A02 Measurement of polarization structure in layered piezoelectric thin films using scanning nonlinear dielectric microscopy	Hiroyuki Odagawa National Institute of Technology, Kumamoto College	Yasuo Cho
H26/A03 Fabrication of various type high-k/Ge structure by plasma processing and evaluation of their near-interface traps	Hiroshi Okamoto Graduate School of Science and Technology, Hirosaki University	Michio Niwano
H26/A04 Development of Fe ₄ N-based magnetic tunnel junctions with ferroelectric tunnel barrier	Masakiyo Tsunoda Graduate School of Engineering, Tohoku University	Masafumi Shirai
H26/A05 Studies on fabrication of ferromagnet/semiconductor hybrid structures and their application for spintronics devices	Fumihiko Matsukura Advanced Institute for Materials Research, Tohoku University	Masafumi Shirai
H26/A06 Highly-Strained and Atomically-Controlled Formation of Ge-Based Group-IV Semiconductors and Nanodevice Application	Masao Sakuraba Research Institute of Electrical Communication, Tohoku University	Michio Niwano

Project Number ----- Research Project Theme	Project Leader	Facilitator in RIEC
H26/A07 ----- Structure-controlled synthesis and property elucidation of two-dimensional emiconductor material	Toshiaki Kato Graduate School of Engineering, Tohoku University	Satoshi Katano
H26/A08 ----- Investigation of high sensitive magnetic sensor with Spin-torque-Oscillator	Yohei Shiokawa Graduate School of Engineering, Tohoku University	Satoshi Katano
H26/A10 ----- Development of Wireless Network Architecture for Dependable Air	Suguru Kameda Research Institute of Electrical Communication, Tohoku University	Suguru Kameda
H26/A11 ----- Study on the organization of cortical circuits	Shigeru Kubota Graduate School of Science and Engineering, Yamagata University	Michio Niwano
H26/A12 ----- Reconstruction of neuronal network for generation of hybrid brain	Haruyuki Kamiya Hokkaido University Graduate School of Medicine	Michio Niwano
H26/A13 ----- Dynamic cues for auditory space perception	Akio Honda Yamanashi Eiwa College	Shuichi Sakamoto
H26/A14 ----- Speech intelligibility estimation without transmission characteristics under long-path echo conditions	Yosuke Kobayashi National Institute of Technology, Miyakonojo College	Shuichi Sakamoto
H26/A15 ----- Study for thin film functional device obtained by controlling normal magnetic field	Tomoo Nakai Industrial Technology Institute, Miyagi Prefectural Government	Kazushi Ishiyama
H26/A16 ----- Development of nanostructured hybrid solar cells	Yasuo Kimura Tokyo University of Technology	Teng Ma
H26/A18 ----- Application of 3D Interactive Technologies to Medical Education based on the Method of Design	Yoshifumi Kitamura Research Institute of Electrical Communication, Tohoku University	Yoshifumi Kitamura
H26/A19 ----- A study on new information processing technology focusing on the flow of information	Keiichi Yasumoto Nara Institute of Science and Technology	Gen Kitagata

Project Number ----- Research Project Theme	Project Leader	Facilitator in RIEC
H26/A20 ----- Study on Cooperative Mechanism of Sympathetic Devices for Mental Status Sharing	Tatsuya Yamazaki Niigata University	Hideyuki Takahashi
H26/A21 ----- An accurate estimation for acoustical transfer function of pinna from camera images	Masashi Itoh Tohoku Institute of Technology	Shuichi Sakamoto
H26/A22 ----- Study of magnetic coupling and spin transport mechanisms in magnetic semiconductors and oxides	Fumihiro Matsukura Advanced Institute for Materials Research, Tohoku University	Hideo Ohno
H26/A23 ----- Japan-Spain International Research Collaboration on Terahertz Sensing Devices	MEZIANI Yahya Moubarak University of Salamanca	Taiichi Otsuji
H26/A24 ----- Study on Direct Digital RF MODEM Technologies	Noriharu Suematsu Research Institute of Electrical Communication, Tohoku University	Noriharu Suematsu
H26/A25 ----- Cultural and individual differences in color lexicon	Keiji Uchikawa Tokyo Institute of Technology	Satoshi Shioiri
H26/A26 ----- Machine Learning Hand-Manipulation for HCI Application	Taku Komura University of Edinburgh	Yoshifumi Kitamura
H27/A01 ----- Fabrication and evaluation of power generation properties of Solid Oxide Fuel Cells using nano-thin film electrolyte	Kiyoshi Uchiyama National Institute of Technology, Tsuruoka College	Yasuo Cho
H27/A02 ----- Basis Establishment of Plasma Nanobio-Medicine	Toshiro Kaneko Graduate School of Engineering, Tohoku University	Michio Niwano
H27/A03 ----- Quantum Heterostructure Formation of Group-IV Semiconductors and Control of Electronic Properties Utilizing Atomically-Controlled Plasma CVD	Masao Sakuraba Research Institute of Electrical Communication, Tohoku University	Michio Niwano

Project Number ----- Research Project Theme	Project Leader	Facilitator in RIEC
H27/A04 ----- Next-generation device researches by using operando spectromicroscopy	Hirokazu Fukidome Research Institute of Electrical Communication, Tohoku University	Hirokazu Fukidome
H27/A05 ----- Development of novel quantum light source for quantum info-communication	Keiichi Edamatsu Research Institute of Electrical Communication, Tohoku University	Keiichi Edamatsu
H27/A06 ----- Nano-scale Geometrical Control and Optical Properties of a Single Metal Nanostructure	Satoshi Katano Research Institute of Electrical Communication, Tohoku University	Satoshi Katano
H27/A07 ----- Computational Study of Plasmons in Semiconductor Two-Dimensional Electron Systems for THz Device Applications	Koichi Narahara Department of Electrical&Electronic Engineering, Kanagawa Institute of Technology	Akira Satou
H27/A08 ----- Studies on resonant tunneling THz signal generators having low phase noise properties	Koichi Maezawa Graduate School of Science and Engineering for Research, University of Toyama	Taiichi Otsuji
H27/A09 ----- A study of carrier conversion system between optical and wireless signal frequency domain for future full-coherent access networks	Naoto Yoshimoto Chitose Institute of Science and Technology	Taiichi Otsuji
H27/A10 ----- A research on reflectarray using metamaterial for propagation improvement in M2M communications	Tamami Maruyama National Institute of Technology, Hakodate College	Noriharu Suematsu
H27/A11 ----- An Empirical Study on SDN-based Networking System based on Changes in User's Physiological Indexes	Masaki Omata Interdisciplinary Graduate School of medicine and Engineering, University of Yamanashi	Gen Kitagata
H27/A12 ----- Effects of self-movements on perception of the surrounding world	Wataru Teramoto Department of Psychology, Faculty of Letters, Kumamoto University	Shuichi Sakamoto

Project Number ----- Research Project Theme	Project Leader	Facilitator in RIEC
H27/A13 ----- Studies on relationship between perception of monaural sound and head-related transfer function	Daisuke Morikawa Japan Advanced Institute of Science and Technology	Shuichi Sakamoto
H27/A14 ----- Construction of functional bio-information devices via combination of silicon microfabrication and lipid bilayers	Ayumi Hirano Graduate School of Biomedical Engineering, Tohoku University	Michio Niwano
H27/A15 ----- The effects of sensory processing speed on audio-visual synchrony perception	Yasuhiro Takeshima Bunkyo Gakuin University	Jorge Trevino
H27/A16 ----- Workshop and Practical Study on the Handing Down of Disaster Experiences from the Perspective of Information Communication Technology	Shosuke Sato International Research Institute of Disaster Science, Tohoku University	Jorge Trevino
H27/A17 ----- Influence of synchrony perception on sense of presence and verisimilitude in multimodal environment	Tomoko Ohtani Tokyo University of the Arts	Jorge Trevino
H27/A18 ----- Influence of speaker's movie of speech utterance on serial recall task	Tomoko Ohtani Tokyo University of the Arts	Shuichi Sakamoto
H27/A19 ----- Development of physical index for speech intelligibility considering long path echo	Hayato Sato Graduate School of Engineering, Kobe University	Yôiti Suzuki
H27/A20 ----- Research on measurement technologies of earthquakes, tsunami, and crustal deformation using an optical-fiber network	Akito Araya Earthquake Research Institute, University of Tokyo	Masataka Nakazawa
H27/A21 ----- Hardware Technology for Brain Computation	Shigeo Sato Research Institute of Electrical Communication, Tohoku University	Shigeo Sato
H27/A22 ----- 3D Flexible Interactions in Multiple Display Environment	Yoshifumi Kitamura Research Institute of Electrical Communication, Tohoku University	Yoshifumi Kitamura

Project Number ----- Research Project Theme	Project Leader	Facilitator in RIEC
H27/A23 ----- Research of Multimodal Agent Framework for Symbiotic Computing	Takahiro Uchiya Information Technology Center, Nagoya Institute of Technology	Tetsuo Kinoshita
H27/A24 ----- Study on knowledge acquisition and utilization for the diversifying information networks	Akinori Takahashi Graduate School of Engineering and Resource Science, Akita University	Tetsuo Kinoshita
H27/A25 ----- Development of a system architecture and infrastructure technology for the Smart Community	Akira Fukuda Graduate School of Information Science and Electrical Engineering, Kyusyu University	Tetsuo Kinoshita
H27/A26 ----- Empirical Researches for introducing ubiquitous systems into the actual life	Yutaka Arakawa Nara Institute of Science and Technology	Hideyuki Takahashi
H27/A27 ----- Research on olfactory multimodal information processes in humans	Nobuyuki Sakai Graduate School of Arts and Letters, Tohoku University	Shuichi Sakamoto
H25/B01 ----- New Principle Nano Devices Based on Precision Control and Observation of Spin Fluctuation and Correlations	Shintaro Nomura Faculty of Pure and Applied Sciences, University of Tsukuba	Hideo Ohno
H25/B02 ----- Fabrication of novel nano-materials based on fine particle plasma physics	Masaharu Shiratani Graduate School and Faculty of Information Science and Electrical Engineering, Kyushu University	Michio Niwano
H25/B03 ----- Research in magnetic materials and magnetic devices for advanced communications equipment	Ken-ichi Yamamoto Faculty of Engineering, University of the Ryukyus	Kazushi Ishiyama
H25/B04 ----- Physics and applications of electric-field control of magnetism	Masafumi Shirai Research Institute of Electrical Communication, Tohoku University	Masafumi Shirai
H25/B05 ----- Novel photonics and nano photonic informatics	Takashige Omatsu Graduate School of Advanced Integration Science, Chiba University	Keiichi Edamatsu

Project Number ----- Research Project Theme	Project Leader	Facilitator in RIEC
H25/B06 ----- Research on Electromagnetic Wave Technologies for Low-Carbon Energy Society	Takashi Ohira Toyohashi University of Technology	Noriharu Suematsu
H25/B07 ----- Studies on cortical mechanisms for visual perception of object-surface attributes	Katsunori Okajima Graduate School of Environment and Information Sciences, Yokohama National University	Ichiro Kuriki
H25/B09 ----- Development and Civilian Use of Microwave and Laser Aided Synthetic Aperture Radar	Yuichiro Kogi Fukuoka Institute of Technology	Hiroshi Yasaka
H25/B10 ----- Logical Approach to Metaprograms	Yukiyoshi Kameyama Faculty of Engineering, Information and Systems, University of Tsukuba	Yoshihito Toyama
H26/B01 ----- Study of functional piezoelectric materials and applications to advanced communication devices	Shin-ichiro Umemura Graduate School of Biomedical Engineering, Tohoku University	Yôiti Suzuki
H26/B02 ----- Research on the new concept devices with integration of nano materials on silicon technology	Heiji Watanabe Graduate School of Engineering, Osaka University	Hideo Ohno
H26/B03 ----- Research for future electronic systems by nano devices and circuits with nano semiconductor materials	Kikuo Yamabe Graduate School of Pure and Applied Sciences, University of Tsukuba	Hideo Ohno
H26/B05 ----- Hybrid Semiconductor Circuit Technologies and Their Applications for Next Generation RFICs	Kenjiro Nishikawa Graduate School of Science and Engineering, Kagoshima University	Noriharu Suematsu
H26/B06 ----- Advanced Communication and Measurement Systems Using Coherent Multicarrier Lightwave	Hidemi Tsuchida National Institute of Advanced Industrial Science and Technology	Masataka Nakazawa
H26/B07 ----- KOTO-mimetics: Rethinking and Recreating Biomimetics	Koichi Oosuka Graduate School of Engineering, Osaka University	Akio Ishiguro

Project Number ----- Research Project Theme	Project Leader	Facilitator in RIEC
H26/B08 ----- Contribution of self-body motion to multisensory integration	Kenzo Sakurai Faculty of liberal arts, Tohoku Gakuin University	Yôiti Suzuki
H26/B09 ----- International Research Collaboration of Brainware LSI	Takahiro Hanyu Research Institute of Electrical Communication, Tohoku University	Takahiro Hanyu
H26/B10 ----- Reliable and Scalable Foundation for Parallel Computing on Many-Core Architecture	Kazuhiko Kato Graduate School of Systems and Information Engineering, University of Tsukuba	Atsushi Ohori
H26/B11 ----- Sensing and Communication Technologies for Human and Mobility	Takeshi Oishi Institute of Industrial Science, The University of Tokyo	Kazuki Takashima
H27/B01 ----- Finding innovative reactive fields related with multi-scale structures in various plasma flows	Akira Ando Graduate School of Engineering, Tohoku University	Maki Suemitsu
H27/B02 ----- Material Development and Applications Using SiC-based Heterostructures	Maki Suemitsu Research Institute of Electrical Communication, Tohoku University	Maki Suemitsu
H27/B03 ----- Physics of quantum measurement and communication	Keiichi Edamatsu Research Institute of Electrical Communication, Tohoku University	Keiichi Edamatsu
H27/B04 ----- Physics and applications of spin dynamics in solids	Fumihiko Matsukura Advanced Institute for Materials Research, Tohoku University	Shun Kanai
H27/B05 ----- Evaluation of telecommunication handset performance under the influence of broadband unnecessary radio wave	Masahiro Yamaguchi Graduate School of Engineering, Tohoku University	Kazushi Ishiyama
H27/B06 ----- Science Education Harmonized between Objectivity and Humanity -For the Issues of Modern Science and Future of Mankind-	Ichiro Tsuda Hokkaido University Graduate School of Science	Hideo Ohno
H27/B07 ----- Parallel processes of brain functions	Ken-ichiro Tsutsui Graduate School of Life Sciences, Tohoku University	Satoshi Shioiri

Project Number Research Project Theme	Project Leader	Facilitator in RIEC
H27/B08 Optimization of Information Representation on a High-Dimensional Neural Network	Akira Hirose Graduate School of Engineering, The University of Tokyo	Shigeo Sato
H27/B09 Functionalization of oxide surfaces and its application to nanodevices	Fumihiko Hirose Graduate School of Science and Engineering, Yamagata University	Michio Niwano
H27/B10 Modeling of dynamic nonverbal behaviors of interpersonal communications	Tatsuo Arai Graduate School of Engineering Science, Osaka University	Yoshifumi Kitamura
H27/B11 Computer Graphics and Interactive Techniques: New Horizon	Yoshifumi Kitamura Research Institute of Electrical Communication, Tohoku University	Yoshifumi Kitamura
H27/B12 Preliminary examination for analysis of asynchronous in network dynamics	Kohei Sonoda Research Organization of Science and Technology, Ritsumeikan University	Kazuto Sasai
H27/B13 Studies on enrichment of media technologies	Naofumi Aoki Hokkaido University Graduate School of Information Science and Technology	Yôiti Suzuki
H27/B14 Evaluations and quantitative verification of disaster resistance and fault tolerance characters on a wide area distributed storage system	Hiroki Kashiwazaki Cybermedia Center, Osaka University	Takaki Nakamura
H26/S1 Project to construct the basis for future science and technology of coherent wave	Hidenori Mimura Research Institute of Electronics, Shizuoka University	Hiroshi Yasaka
H26/S2 Spintronics Academic Alliance	Masaaki Tanaka Graduate School of Engineering, The University of Tokyo	Masafumi Shirai
H26/S3 Collaborative Research on Nano-electronics	Katsuyuki Utaka Institute for Nanoscience & Nanotechnology, Waseda University	Michio Niwano
H27/S1 Empathic Computing System through interactive knowledge emergence based on massive data processing	Kazunori Komatani The Institute of Scientific and Industrial Research, Osaka University	Yoshifumi Kitamura

5. Symposium organized by the Institute

This Symposium is planned to exchange relevant information on current important topics concerning Electrical Eng., Electrical Communications, Electronic Eng., and Information Eng. Many related researchers inside and outside Tohoku University participate the Symposium and stimulate discussion.

Symposium In Past

	Title	Date
1	Quantum Electronics of Light Waves and Micro Waves	Feb. 6- 8, 1964
	Magnetic Recording	Feb.14-15, 1964
2	Ultra-High Frequency Acoustoelectronics	Feb.11-12, 1965
3	Artificial Intelligence	Mar. 8- 9, 1966
4	Thin Film Electronics	Jan.26-27, 1967
5	Crystal Growth	Dec. 19-20, 1967
6	1968 Sendai Symposium on Acoustoelectronics	Aug.19-20, 1968
7	Current Status and Future Trends of Superconductivity	Jan.22-24, 1970
8	Speech Information Processing	Feb.24-26, 1971
9	Surface Acoustic Wave Technology	May.25-26, 1972
10	Liquid Crystals · Their Molecular Orientations and Application to Display Devices	Dec.13-14, 1974
11	Computer Network	Mar.17-18, 1975
12	The Memorial Symposium on the 40th Anniversary of the Foundation of RIEC	Sep.25-26, 1975
13	Application of Amorphous Ferromagnetic Materials	Mar.10-11, 1977
14	Stoichiometry of Compound Crystals	Nov.24-25, 1977
15	Submillimeter Waves	Nov.16-17, 1978
16	Solid State Chemical Sensors	Feb. 1- 2, 1980
17	Graph Theory and Algorithms	Oct.24-25, 1980
18	Perpendicular Magnetic Recording	Mar.11-12, 1982
19	Approach to Optical Computer	Mar.10-11, 1983
20	Plasma Non-Linear Phenomena · Basic Problems for Fusion Plasmas	Mar. 8- 9, 1984
21	New Computer Architecture	Jul.25-26, 1985
22	Guided Wave Technology and Its Application at Mid-Infrared	Mar.13-14,1986
23	Physics and Applications of Tunnelling Phenomena	Mar.12-14, 1987
24	Biomagnetics and Bioelectronics	Feb.26-27, 1988
25	Ultrasonic Electronics · New Applications of Piezoelectricity	Feb. 2- 3, 1989
26	Boundaries between Light and Electromagnetic Wave	Feb. 1-2, 1990

27	Issues and Realization of Pattern Recognition and Understanding	Feb.28-Mar.1,1991
28	Discrete Algorithms	Oct.17-18, 1991
29	Perspective for New Computing Paradigm	Feb. 4- 5, 1993
	Current Status and Future Prospects of System Control	Mar. 3- 4, 1993
30	Future Prospects of Electron Beam Devices	Nov. 1- 2, 1993
31	Discharge and EMC	Dec.20-21, 1994
32	Statistical Physics and Information Science	Mar.22-23,1995
33	Photo-and Plasma-Excited Processes on Surfaces	Nov.30-Dec.1,1995
34	Nano Spinics and Power Electronics	Feb.15-16, 1996
35	Potential Formation and Related Nonlinear Phenomena in Plasmas	Sep.17-19, 1996
36	New Trend in Ultrasonic Measurements	Feb. 3- 4, 1997
37	Toward the Realization of the High-Definition Multi-Media Communication	Nov. 4- 6, 1997

International Symposium Organized by the Institute

	Title	Date
1	Intrinsic Josephson Effect and THz Plasma Oscillation in High T _c Superconductors	Feb.23-25, 1997
2	Design and Architecture of Information Processing Systems Based on The Brain Information Principle	Mar.16-18, 1998
3	Novel Techniques and Applications of Millimeter-Waves	Dec.14-16, 1998
4	The International Joint Conference on Silicon Epitaxy and Heterostructures	Sep.13-17, 1999
5	International Workshop on Photonic and Electromagnetic Crystal Structures	Mar.8-10, 2000
6	Physics and Application Spin Related Phenomena in Semiconductors	Sep.13-15, 2000
7	Rewriting in Proof and Computation	Oct.25-27, 2001
8	Nonlinear Theory and its Applications	Oct.28-Nov.1, 2001
9	New Paradigm VLSI Computing	Dec.12-14, 2002
10	Ultra High Density Spinic Storage System	Oct.23-24, 2003
11	3rd International Workshop on New Group IV (Si-Ge-C) Semiconductors	Oct.12-13, 2004
12	3rd International Workshop on High Freaquency Micromagnetic Devices and Materials (MMDM3)	Apr.11-12, 2005
13	4th International Conference on Silicon Epitaxy and Heterostructures (ICSI-4)	May 23-26, 2005
14	1st International WorkShop on New Group IV Semiconductor Nanoelectronics	May 27-28. 2005
15	GSIS International Symposium on Information Sciences of New Era: Brain, Mind and Society	Sep.26-27, 2005
16	The 1st RIEC International Workshop on Spintronics -Spin Transfer Phenomena-	Feb.8-9, 2006
17	4th International Workshop on High Frequency Micromagnetic Devices and Materials (MMDM4)	May 8,2006
18	4th International Conference on Physics and Applications of Spin-Related Phenomena in Semiconductors (PASPS-IV)	Aug.15-18,2006
19	2nd International Workshop on New Group IV Semiconductor Nanoelectronics	Oct.2-3,2006
20	2nd RIEC International Workshop on Spintronics	Feb.15-16,2007
21	Japan-China Joint Conference on acoustics, JCA2007	Jun.4-6,2007
22	International Conference on Discovery Science/ International Conference on Algorithmic Learning Theory	Oct.1-4,2007
23	The 3rd RIEC International Workshop on Spintronics	Oct. 31-Nov.1,2007
24	3rd International Workshop on New Group IV Semiconductor Nanoelectronics	Nov.8-9,2007
25	International Workshop on Nanostructures & Nanoelectronics	Nov.21-22,2007
26	The 18th International Symposium on Algorithms and Computation(ISAAC2007)	Dec.17-19,2007
27	International Interdisciplinary-Symposium on Gaseous and Liquid Plasmas (ISGLP 2008)	Sep.5-6,2008

28	4th International Workshop on New Group IV Semiconductor Nanoelectronics	Sep.25-27,2008
29	The 4th RIEC International Workshop on Spintronics	Oct.9-10,2008
30	Global Symposium on Millimeter Waves 2009 (GSMM2009)	Apr.20-22,2009
31	Mini R.I.E.C. workshop on multimodal perception	Apr.24,2009
32	The 4th International Symposium on Ultrafast Photonic Technologies	Aug.4-5,2009
33	PIMRC2009 Personal Indoor and Mobile Radio Communications Symposium 2009	Sep.13-16,2009
34	2nd RIEC-CNSI Workshop on Nanoelectronics,Spintronics and Photonics (5th RIEC Symposium on Spintronics)	Oct.22-23,2009
35	International Workshop on the principles and applications of spatial hearing 2009 (IWPASH2009)	Nov.11-13,2009
36	5th International Workshop on New Group IV Semiconductor Nanoelectronics	Jan.29-30,2010
37	6th RIEC International on Spintronics	Feb.5-6,2010
38	2nd International Workshop on Nanostructure & Nanoelectronics	Mar.11-12,2010
39	2nd RIEC International Symposium on Graphene Devices (ISGD2010)	Oct.27-29,2010
40	9th Japan-Korea Symposium on Surface Nanostructures	Nov.15-16,2010
41	The 7th RIEC International Workshop on Spintronics	Feb.3-4,2011
42	The 42nd RIEC International Symposium 12th International Multisensory Research Forum (IMRF2011)	Oct.17-20,2011
43	The 8th RIEC International Workshop on Spintronics	Feb.2-3,2012
44	The Sixth International Symposium on Medical, Bio- and Nano-Electronics	Mar.8,2012
45	3rd International Workshop on Nanostructures & Nanoelectronics	Mar.21-22,2012
46	9th RIEC International Workshop on Spintronics	May 31-Jun.2,2012
47	The 1st International Workshop on Smart Technologies for Energy, Information and Communication (STEIC2012)	Oct.18-19,2012
48	Technical University of Dresden and Tohoku University Symposium 2012	Nov.2,2012
49	The 1st RIEC International Symposium on Brain Functions and Brain Computer	Nov.15-16,2012
50	Tohoku – Harvard Joint Workshop New Directions in Materials for anoelectronics,Spintronics and Photonics (10th RIEC International Workshop on Spintronics)	Jan.15-16,2013
51	11th RIEC International Workshop on Spintronics & 3rdCSISInternationalSymposiumonSpintronics-based VLSIs	Jan.31-Feb.1,2013
52	7th International Symposium on Medical, Bio- and Nano-Electronics	Mar.7,2013
53	6th Global Symposium on Millimeter Wave 2013	Apr.22-23,2013

54	The 2nd RIEC International Symposium on Brain Functions and Brain Computer	Feb.21-22,2014
55	8th International Symposium on Medical,Bio- and Nano-Electro	Mar.6-7,2014
56	5th International Workshop on Nanostructures and Nanoelectronics	Mar.6-7,2014
57	12th RIEC International Workshop on Spintronics	Jun.25-27,2014
58	The IEEE International Conference on Microwave Magnetics	Jun.29-Jul.2,2014
59	RIEC International Symposium on Perception and Communication	Jul.24,2014
60	APMC 2014(2014 Asia-Pacific Microwave Conference)	Nov.4-7,2014
61	The 3rd RIEC International Symposium on Brain Functions and Brain Computer	Feb.18-19,2015
62	International Symposium on Brainware LSI	Mar.2-3,2015
63	The 9th International Symposium on Medical, Bio- and Nano-Electronics	Mar.2-4,2015
64	The 6th International Workshop on Nanostructures and Nanoelectronics	Mar.2-4,2015
65	RIEC International Symposium on Vision and Cognition	Mar.20,2015
66	The 23rd Symposium of the International Colour Vision Society (ICVS 2015)	Jul. 3-7, 2015
67	RIEC International Symposium on Computer Graphics and Interactive Techniques: New Horizon	Sep. 26-27,2015
68	13th RIEC International Workshop on Spintronics	Nov. 18-20,2015
69	The 4th RIEC International Symposium on Brain Functions and Brain Computer	Feb. 23-24,2016
70	International Symposium on Brainware LSI	Feb. 26-27,2016
71	The 10th International Symposium on Medical, Bio- and Nano-Electronics	Mar. 1-3,2016
72	The 7th International Workshop on Nanostructures and Nanoelectronic	Mar. 1-3,2016

6. Study Groups on Electrical Communication

Study Groups on Electrical Communication are organized to solve scientific and technological problems and to promote research and development through the collaboration of the Research Institute of Electrical Communication, Group of ECEI (Electrical Engineering, Communication Engineering, Electronic Engineering, and Information Engineering) in Graduate Schools of Engineering, Information Sciences, Biomedical Engineering, related scientists and engineers inside and outside Tohoku University. The Study Groups on Electrical Communication consist of 15 Sub-Groups as listed, to deal with specific subjects. Each Sub-Group holds workshops and the abstracts of the workshops are published annually in *The Record of Electrical and Communication Engineering Conversation Tohoku University*.

Many scientists and engineers not only from universities but also from government laboratories and industries attend the workshops, present papers, and discuss issues actively. We are pleased to provide information on these activities upon request. Please contact the General Chairman or each Sub-Group Chairman for general information or more specific questions.

<i>Electromagnetic and Optical Waves Engineering</i>	
Chair	Prof. Hirohito Yamada
Manager	Associate Prof. Yasuo Ohtera

<i>Acoustic Engineering</i>	
Chair	Prof. Yôiti Suzuki
Manager	Associate Prof. Shuichi Sakamoto
Manager	Lecturer Takashi Nose

<i>Sendai "Plasma Forum"</i>	
Chair	Prof. Akira Ando
Manager	Prof. Toshiro Kaneko

<i>Sendai Seminar on EMC</i>	
Chair	Prof. Hideaki Sone
Manager	Prof. Masahiro Yamaguchi

<i>Computer Science</i>	
Chair	Prof. Eijiro Sumii
Manager	Associate Prof. Kazutaka Matsuda

<i>Systems Control</i>	
Chair	Prof. Makoto Yoshizawa
Manager	Associate Prof. Norihiro Sugita

<i>Information-biotronics</i>	
Chair	Prof. Tatsuo Yoshinobu
Manager	Associate Prof. Ayumi Hirano

<i>Spinics</i>	
Chair	Prof. Kazushi Ishiyama
Manager	Associate Prof. Yasushi Endo
Manager	Assistant Prof. Tomoyuki Ogawa

<i>New Paradigm Computing</i>	
Chair	Prof. Takahiro Hanyu
Manager	Associate Prof. Naofumi Homma

<i>Ultrasonic Electronics</i>	
Chair	Prof. Shin-ichiro Umemura
Manager	Associate Prof. Shin Yoshizawa

<i>Brainware</i>	
Chair	Prof. Akio Ishiguro
Manager	Assistant Prof. Takeshi Kano

<i>Mathematical Physics and its Application to Information Sciences</i>	
Chair	Prof. Kazuyuki Tanaka
Manager	Associate Prof. Yuji Waizumi

<i>Biocybernetics and Bioinformatics</i>	
Chair	Prof. Satoshi Shioiri
Manager	Associate Prof. Takeshi Obayashi
Manager	Associate Prof. Kazumichi Matsumiya

<i>Nanoelectronics and Spintronics</i>	
Chair	Prof. Shigeo Sato
Manager	Prof. Michio Niwano

<i>Advanced Information Communication Engineering</i>	
Chair	Prof. Tetsuo Kinoshita
Manager	Associate Prof. Gen Kitagata

7. International Activities

Many of the staff in RIEC contribute to the development of technology and science in the world by serving as editors of referees of international journals or by chairing or programming international conferences. In some fields in electronics, electrical communications, or information engineering RIEC serves as a Center of Excellence (COE), which attracts many visiting researchers and students from all over the world every year. Several academic exchange programs with foreign colleges or institutes are in operation.

International academic exchange programs:

- The Institute of Physics, Polish Academy of Sciences (Poland)
 - * The Faculty of Science, Chulalongkorn University (Thailand)
 - * Harbin Institute of Technology (China)
 - * The James Frank Institute, The University of Chicago (U.S.A.)
 - * Queen Mary and Westfield College, University of London (U.K.)
 - * Scientific Research Department, Shenzhen University (China)
 - * Institute of Information and Communication Technology, Sung-Kyun-Kwan University (Korea)
 - * Institute of Materials Science, Faculty of Applied Physics, University of Twente (Netherlands)
 - * The Institute of Radioengineering and Electronics Russian Academy of Sciences (Russia)
 - * Department of Electronics Science and Engineering, University of Nanjing (China)
 - * School of Computer and Communication Engineering, Taegu University (Korea)
 - The Interdisciplinary Center on Nanoscience of Marseille, National Center of Scientific Research (France)
 - IHP-Innovations for High Performance Microelectronics (Germany)
 - Institute of Semiconductors Chinese Academy of Sciences (China)
 - WINLAB, Rutgers University (U.S.A.)
 - University of Vigo (Spain)
 - State University of New York, College of Nanoscale Science and Engineering(CNSE)(U.S.A)
 - Department of Physics, National Sun Yat-Sen University (Taiwan)
 - Research and Educational Center “Photonics and Infrared Technology” and Institute of Radio Electronics and Laser Technology, Bauman Moscow State Technical University (Russia)
 - Research Laboratory of Electronics and Microsystems Technology Laboratories, Massachusetts Institute of Technology(MIT)(U.S.A.)
- (*: expired program)

International journals in which a staff in RIEC participates as an editor:

1	Acoustical Science and Technology
2	Acta Acustica Sinica
3	Applied Acoustics
4	Applied Intelligence
5	Frontiers in Virtual Environments (a section of Frontiers in Robotics and AI)
6	IEEE Magnetics Letter
7	IEICE Electronics Express
8	IEICE Trans. Commun.
9	Interdisciplinary Information Sciences
10	International Journal of Energy, Information and Communication

11	Japanese Journal of Applied Physics
12	Journal of Magnetism, Korean Magnetism Society
13	Journal of SPIN
14	Nature Communications
15	Nature Scientific Reports
16	Neural Networks
17	Nonlinear Theory and Its Applications, IEICE
18	NPG Asia Materials
19	Optical Fiber Technology
20	Optical Review
21	Scientific Reports
22	The Journal of Computer Animation and Virtual Worlds (John Wiley & Sons, Inc.)

Recent international conferences programmed by a staff in RIEC

1	13th RIEC International Workshop on Spintronics
2	17th International Multisensory Research Forum (IMRF2016)
3	1st International Conference on Enterprise Architecture and information Systems (EAIS2016)
4	2015 IEEE International Symposium on Radio-Frequency integration Technology (RFIT2015)
5	21st International Conference on Electronic Properties of Two-Dimensional Systems (EP2DS) and the 17th International Conference on Modulated Semiconductor Structures (MSS)
6	40th International Conference on Infrared, Millimeter and THz Waves (IRMMW-THz 2015)
7	ACM SIGCHI
8	ACM SIGGRAPH
9	ACM SIGGRAPH Asia 2015: The 8th SIGGRAPH Conference and Exhibition on Computer Graphics and Interactive Techniques in Asia 2015
10	ACM Symposium on Virtual Reality Software and Technology (VRST)
11	Asia-Pacific Microwave Conference (APMC)
12	Asia-Pacific Workshop on Fundamentals and Applications of Advanced Semiconductor Devices(AWAD)
13	EGVE: Eurographics Workshop on Virtual Environment (EGVE)
14	European Conference on Optical Communication (ECOC)
15	European Solid-State Device Research Conference(ESSDERC)
16	Hiding and Multimedia Signal Processing (IIH-MSP2015)
17	IEEE International Conference on Web Intelligence(WI)
18	IEEE International Symposium on Asynchronous Circuits and Systems
19	IEEE International Symposium on Multiple-Valued Logic
20	IEEE NEMS 2016
21	International Advisory Committee, 8th International School and Conference on Spintronics and Quantum Information Technology (SPINTECH-8)
22	International Conference Industrial & Engineering Applications of Artificial intelligence & Expert Systems (IEA/AIE)

23	International Conference on Artificial Reality and Tele-existence (ICAT)
24	International Conference on Electron Dynamics in Semiconductors, Optoelectronics and Nanostructures(EDISON)
25	International Conference on Indium Phosphide and Related Materials (IPRM)
26	International Conference on Recent Progress in Graphene Research (RPGR)
27	International Conferences on Modern Materials & Technologies(CIMTEC)
28	International Federation for Information Processing (IFIP) Human-Computer Interaction (TC-13)
29	International Symposium on Advanced and Applied Convergence
30	International Symposium on Compound Semiconductors (ISCS)
31	International Symposium on Frontiers in THz Technology (FIT)
32	International Workshop: Spintronics VLSI
33	Optical Fiber Communication Conference (OFC)
34	Opto-Electronics and Communications Conference (OECC)
35	Russia-Japan-USA-Europe Symposium on Fundamental & Applied Problems of Terahertz Devices & Technologies (RJUSE)
36	SPIE International Conference on Defense, Commercial, and Sensing
37	Technical Committee of Multiple-Valued Logic, IEEE Computer Society
38	The 11th Asia-Pacific Conference on Vision (APCV 2015)
39	The 11th International Conference on Intelligent Information
40	The 23rd Symposium of the International Colour Vision Society (ICVS 2015)
41	The 25th IEEE International Semiconductor Laser Conference (ISLC) 2016
42	The 28th International Conference on Indium Phosphide and Related Materials (IPRM)2016
43	The Fourth Asian Conference on Informatino Systems (ACIS2015)
44	The magnetic Recoeding Conference 2017
45	Topical Workshop on Heterostructure Microelectronics(TWHM)
46	VLSI Circuits Symposium
47	York-Tohoku-Kaiserslautern Research Symposium on “New Concept Spintronics Devices”

8. Periodicals Published by the Institute

The Institute publishes the following two periodicals to inform readers on recent research results of the Institute.

1. The Record of Electrical and Communication Engineering *Conversazione* Tohoku University

This journal aims at providing an opportunity to publish research results of the Institute as well as the result of the Graduate School of Engineering, Information Sciences, Biomedical Engineering. Since the journal also aims at publishing general research activities of the Institute and of the Graduate School such as records of the final lectures of retiring professors, records of the Institute Symposium, and reviews.

The name of the Journal ‘*Conversazione*’ is attributable to the ‘Tuesday *Conversazione*’ at the Department of Electrical Engineering, which had been held once a week on Tuesday since around 1920. Minutes of the meetings had been distributed to researchers outside of the University via various routes and therefore some of them had been referred to as ‘Records of Tuesday Electrical Engineering *Conversazione* Tohoku University’ with the result that they came to be treated as official publications.

Though the meeting was once interrupted by World War Two, it was restarted in 1947. In 1952, the publication of the records was succeeded by the Institute and the records have been published as periodicals, two or three times a year recently, since No. 1 Vol. 21 was published in July, 1952.

2. The Annual Report of Research Activity at the Research Institute of Electrical Communication, Tohoku University

Published annually since 1995. This report details the activities of each research division and research facility. Also included are reports on nation-wide co-operative research projects, international symposium and seminars organized by members of RIEC, and the reports and evaluation on the RIEC advisory board members. English edition(digest version of Japanese edition) has been published since 2007.

3. RIEC News

As a part of RIEC’s publication service, “RIEC News” is published.

With the 75th anniversary of the establishment of RIEC, RIEC News introduces cutting-edge’s

research and the vision of the future from RIEC's contributions to the progression of science and technology in Japan. RIEC News was first launched in March 2011, In fiscal year 2015, 14th, 15th and 16th issues were published. Every issue introduces special topics such as large scale projects and Specially-Promoted Research, etc. RIEC News also includes current information about each laboratory and center, all kinds of RIEC events, research exchange meetings, laboratories open to the public (RIEC Open Day), etc. English version is also published in March 2014. Further, RIEC News offers a notification service by mail whenever a new issue is released and an electronic version of every issue published so far can be downloaded by following the link below.

<http://www.riec.tohoku.ac.jp/riecnews/>

9. Staff, Budget

1. Faculty & Staff

as of May 1, 2015

Professors	22
Associate Professors	19
Assistant Professors	22
Research Fellows	15
Specially Appointed Professors	1
Administrative Staff	16
Technical Staff	11
Total	106

2. Researchers (FY2015)

Foreign Researchers	Visiting Professors	3
	Visiting Associate Professors	4
Cooperative Researchers of Private Company etc		2
JSPS Research Fellowship for Young Scientists		8
JSPS Postdoctoral Fellowship for Overseas Researchers		1
Contract Researchers		10
Contract Trainees		1
Total		29

3. Students

as of May 1, 2015

	School of Engineering	Graduate School of Information Science	Graduate School of Biomedical Engineering	RIEC	Total
Undergraduate Students	52				52
Master Course Students	77 (6)	36 (7)	4		117 (13)
Doctor Course Students	28 (7)	8 (2)			36 (9)
Research Students				5 (3)	5 (3)
Total	157 (13)	44 (9)	4	5 (3)	210 (25)

*() Foreigner

4. Budget

Budget Shift

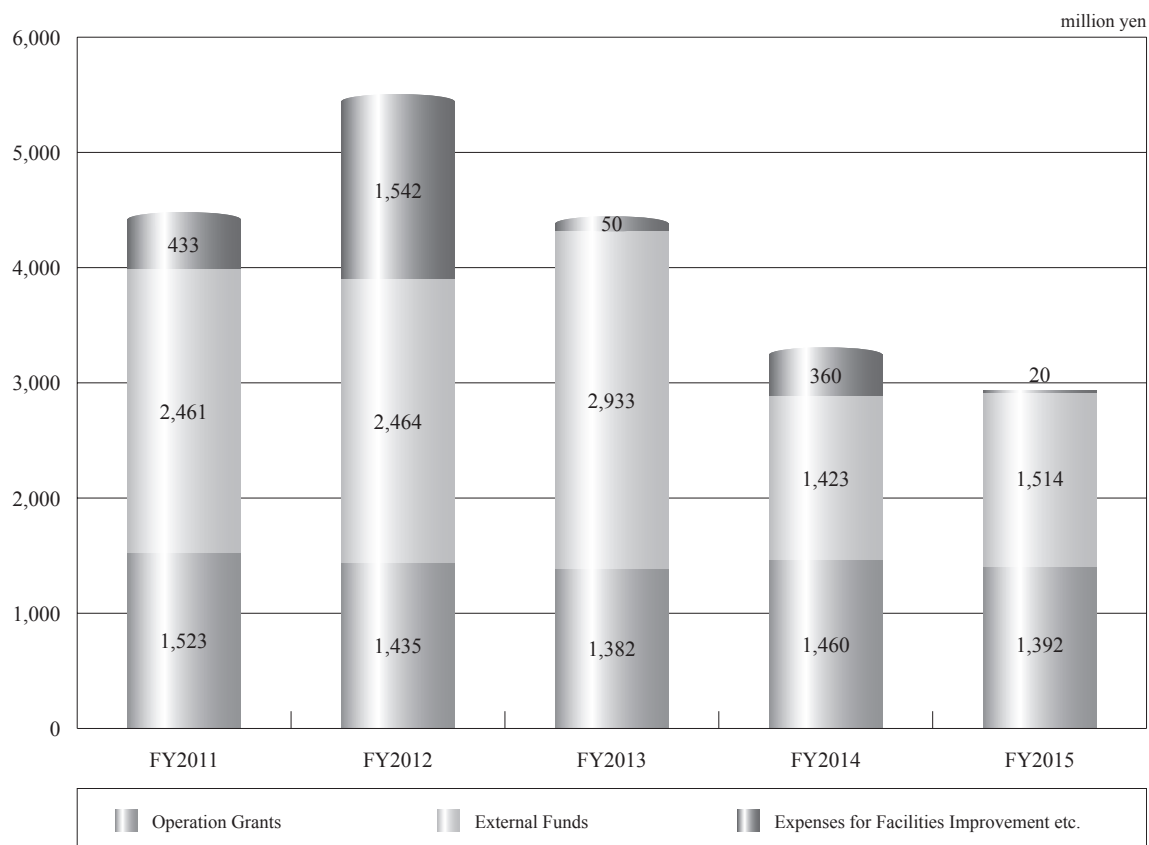

Budget Summary

thousand yen

Categories		FY2011	FY2012	FY2013	FY2014	FY2015
Operation Grants	Personnel Expenses	835,898	770,443	723,507	791,174	724,798
	Non-Personnel Expenses	687,253	665,038	658,590	668,941	667,582
Operation Grants Total		1,523,151	1,435,481	1,382,097	1,460,115	1,392,380
External Funds	Grants-in-Aid for Scientific Research	469,840	407,629	343,824	399,311	422,846
	Funds for Commissioned Research	1,122,944	1,344,071	1,890,012	1,007,060	1,076,220
	FIRST Program※1・NEXT Program※2	813,777	671,668	660,578	0	0
	Donations	54,167	40,714	38,100	16,890	14,490
	Indirect Expenses	311,801	326,869	336,037	212,669	219,886
External Funds Total		2,460,728	2,464,082	2,932,514	1,423,261	1,513,556
Expenses for Reconstruction		432,607	4,993	0	0	0
Expenses for Relocation		0	0	49,632	359,770	20,011
Expenses for Facilities Improvement		0	1,536,530	0	0	0
Expenses for Facilities Improvement etc. Total		432,607	1,541,523	49,632	359,770	20,011
Total		4,416,486	5,441,086	4,364,243	3,243,146	2,925,947

※1 FIRST Program...Funding Program for World-Leading Innovative R&D on Science and Technology (JSPS)
 ※2 NEXT Program...Funding Program for Next Generation World-Leading Researchers(JSPS)

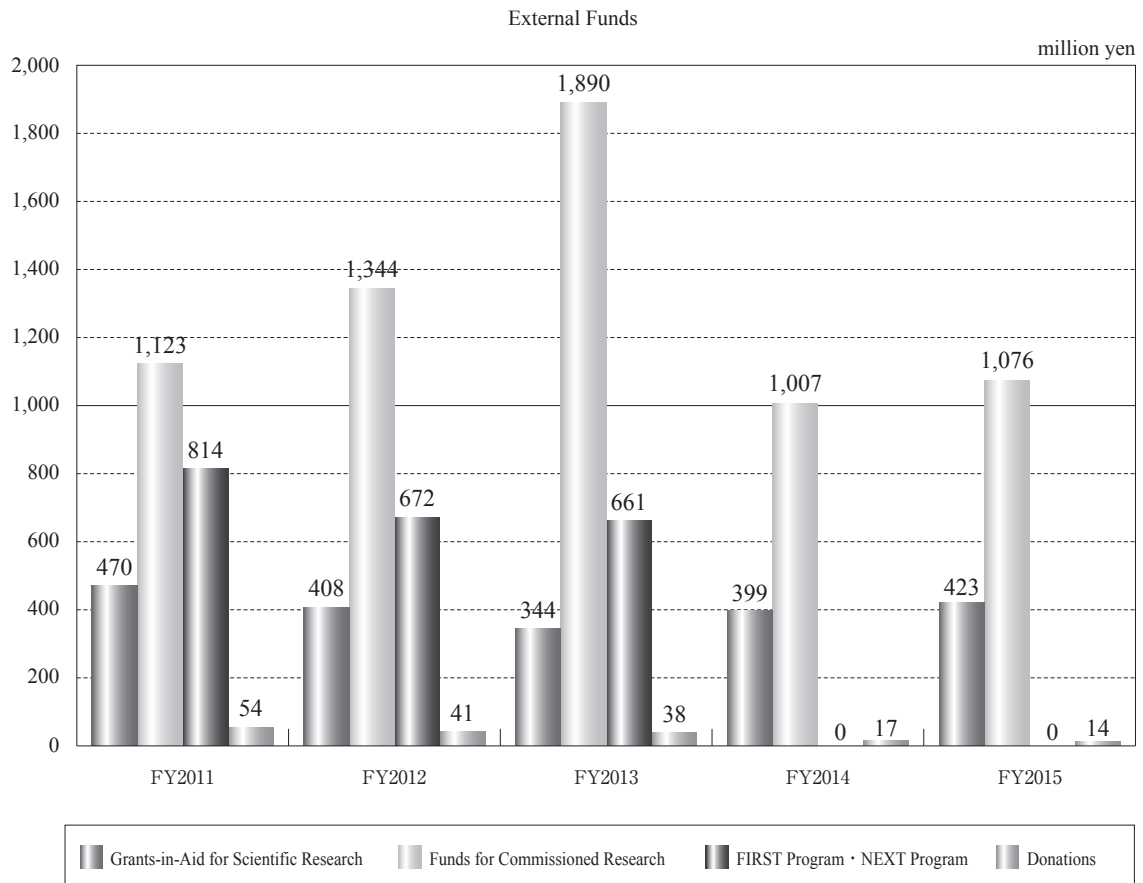

External Funds

thousand yen

Categories	FY2011	FY2012	FY2013	FY2014	FY2015
Grants-in-Aid for Scientific Research	469,840	407,629	343,824	399,311	422,846
Funds for Commissioned Research	1,122,944	1,344,071	1,890,012	1,007,060	1,076,220
FIRST Program※1 · NEXT Program※2	813,777	671,668	660,578	0	0
Donations	54,167	40,714	38,100	16,890	14,490
Total	2,460,728	2,464,082	2,932,514	1,423,261	1,513,556

※1 FIRST Program...Funding Program for World-Leading Innovative R&D on Science and Technology (JSPS)
 ※2 NEXT Program...Funding Program for Next Generation World-Leading Researchers(JSPS)

Annual Report 2015



RIEC

Research Institute of Electrical Communication
Tohoku University

2-1-1Katahira, Aobaku, Sendai 980-8577, Japan
Tel. +81-(0)22-217-5422 Fax. +81-(0)22-217-5426
<http://www.riec.tohoku.ac.jp/>